



INSTRUCTIONS MANUAL

im Vertrieb von:

DOGATEC
Mit Sicherheit montiert

Tel.: +49/7361/8049950
D-73430 Aalen
www.dogatec.de

IMPORTANT



The tool delivered with this manual may have been modified for specific needs.

In that case, please give us the tool code number written on our shipping note or the approximate tool delivery date when you place an order for a new similar tool or for spare parts.

In that way, you will be sure to get the required tool and/or spare part.

WARNING

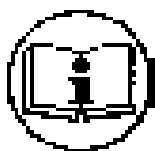

This information has to be kept in a location known by all users.



Each operator has to read carefully this manual before installing, using, and mending the product.

Be sure that the operator has understood using recommendations and the meaning of signs put on the product.

Most accidents could be avoided respecting this Manual Instructions. As a matter of fact, they were created according to European laws and norms regarding products.

In each case, please respect and follow safety national norms. Do not take off nor damage the stickers or advise put on the product and above all the details imposed by the law.

INDEX

1. General safety rules	p.4
1.1 Work area	p.4
1.2 Electrical safety	p.4
1.3 Personal safety	p.4
1.4 Tool use and Care	p.5
1.5 Service	p.5
2. Specific safety rules	p.5
3. Electric specification	p.6
4. Mechanical specification	p.6
5. Selectable INPUT VOLTAGE	p.6
6. Pin configuration of output	p.6
7. Selectable OUTPUT voltage	p.7
8. Over current protection, over heat protection and reset	p.7
9. Connections	p.8
10. Interface with XS-40D controller	p.9
10.1 Connector and cables	p.9
10.2 Interface for start / stop signal	p.9
10.3 Timing chart of start / stop signal	p.9
10.4 Interface converter (Option)	p.10
11. Interface with XS-40D FA controller	p.12
11.1 Connection and cables	p.12
11.2 Positive(+) Common wiring	p.13

1. General safety rules

WARNING! Read and understand all instructions. Failure to follow all instructions listed below, may result in electric shock, fire and/or serious personal injury.

SAVE THESE INSTRUCTIONS

1.1 Work Area

- Keep your work area clean and well lit. Cluttered benches and dark areas invite accidents.
- Do not operate power tools in explosive atmospheres, such as in the presence of flammable liquids, gases, or dust. Power tools create sparks which may ignite the dust or fumes.
- Keep bystanders, children, and visitors away while operating a power tool. Distractions can cause you to lose control.

1.2 Electrical Safety

- Grounded tools must be plugged into an outlet properly installed and grounded in accordance with all codes and ordinances. Never remove the grounding prong or modify the plug in any way. Do not use any plugs. Check with a qualified electrician if you are in doubt as to whether the outlet is properly grounded. If the tools should electrically malfunction or break down, grounding provides a low resistance path to carry electricity away from the user.
- Avoid body contact with grounded surface ad pipes, radiators, ranges and refrigerators. There is an increased risk of electric shock if your body is grounded.
- Don't expose power tools to rain or wet conditions. Water entering a power tool will increase the risk of electric shock.
- Do not abuse the cord. Never use the cord to carry the tools or pull the plug from an outlet. Keep cord away from heat, oil, sharp edges or moving parts. Replace damaged cords immediately. Damaged cords increase the risk of electric shock.
- When operating a power tool outside, use an outdoor extension cord marked W-A or W. These cords are rated for outdoor use and reduce the risk of electric shock.

1.3 Personal Safety

- Stay alert, watch what you are doing and use common sense when operating a power tool. Do not use tool while tired or under the influence of drugs, alcohol, or medication. A moment of inattention while operating power tools may result in serious personal injury.
- Dress properly. Do not wear loose clothing or jewelry. Contain long hair. Keep your hair, clothing, and gloves away from moving parts. Loose clothes, jewelry, or long hair can be caught in moving parts.
- Avoid accidental starting. Be sure switch is off before plugging in. Carrying tools with your finger on the switch or plugging in tools may result in personal injury.
- Remove adjusting keys or switches before turning the tool on. A wrench or a key that is left attached to a rotating part of the tool may result in personal injury.
- Do not overreach. Keep proper footing and balance at all times. Proper footing and balance enables better control of the tool in unexpected situations.
- Use safety equipment. Always wear eye protection. Dust mask, non-skid safety shoes, hard hat, or hearing protection must be used for appropriate conditions.

1.4 Tool use and Care

- Use clamps or other practical way to secure and support the workplace to a stable platform. Holding the work by hand or against your body is unstable and may lead to loss of control.
- Do not force tool. Use the correct tool for your application. The correct tool will do the job better and safer at the rate for which it is designed.
- Do not use tool if switch does not turn it on or off. Any tool that cannot be controlled with the switch is dangerous and must be repaired.
- Disconnect the plug from the power source before making any adjustments, changing accessories, or storing the tool. Such preventive safety.
- Store idle tools out of reach of children and other untrained persons. Tools are dangerous in the hands of untrained users.
- Maintain tools with care. Keep cutting tools sharp and clean. Properly maintained tools, with sharp cutting edges are less likely to bind and are easier to control.
- Check for misalignment or binding of moving parts, breakage of parts, and any other condition that may affect the tools operation. If damaged, have the tool serviced before using. Many accidents are caused by poorly maintained tools.
- Use only accessories that are recommended by the manufacturer for your model. Accessories that may be suitable for one tool, may become hazardous when used on another tool.

1.5 Service

- Tool service must be performed only by qualified personnel. Service or maintenance performed by unqualified personnel could result in a risk of injury.
- When servicing a tool, use only identical replacement parts. Follow instructions in the Maintenance section of this manual. Use of unauthorized parts or failure to follow Maintenance instructions may create a risk of electric shock or injury.

2. Specific safety rules

2.1 Hold tool by insulated gripping surfaces when performing an operation where the cutting tool may contact hidden wiring or its own cord. Contact with a "live" wire will make exposed metal parts of the tool "live" and shock the operator.

2.2 Never lubricate aerosol oil on to the electrical part.

3. Electric specification

Model	XS-40D
Input	120 / 230VAC (selectable)
Output	30 / 40 VDC (selectable) +5%
Rated power	2.6A 105W
Maximum output current	10 A
Intermittent operation	10s On / 30s Off
Safety system	CE certified (Class I)

4. Mechanical specification

Size : 98 x 158 x 55H (mm)
 Weight : 850 gr
 Power cord : 1.5 m
 Fuse : 10 A 250V

5. Selectable INPUT VOLTAGE at the back of the controller

For changing the input voltage, loosen two screws and assemble the cover as below.

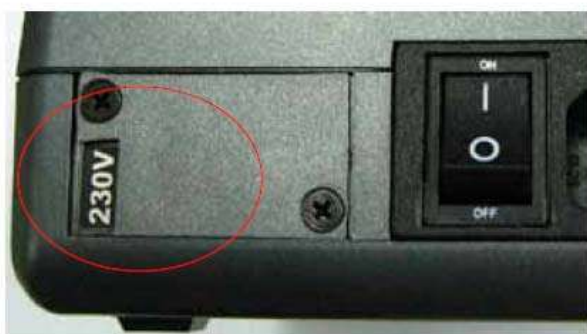

230VAC selected



110VAC selected

6. Pin configuration of output

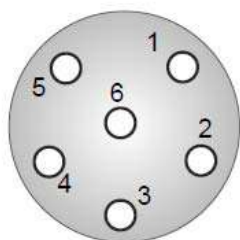

- 1 : DC (+)
- 2 : Limit (Torque up)
- 3 : Ground
- 4 : Start
- 5 : DC (-)
- 6 : Driver Lock or Remote start
(for "A" option driver)

Caution : Do not connect the others except the listed screwdrivers. It may cause electric shock, fire and any dangerous situation.

7. Selectable OUTPUT voltage

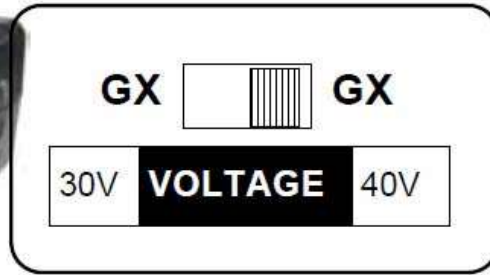

GX series - 30VDC (GX80 - GX120)

GX series - 40VDC (GX150 - GX 220 - GX 450)

8. Over Current Protection (Overload), Over heat protection and reset

Description		Over Current Protection	Over Heat Protection
Detection	Limit	8 A current	90°C
	Time duration	Immediately	
Protection		Whole power shut down permanently	
Protection signal	LED	No power	
	Buzzer	No power	
Recovery		Turn off the power switch and on after 1 min.	Turn the power switch off and on at lower than 90°C temperature.

9. Connections

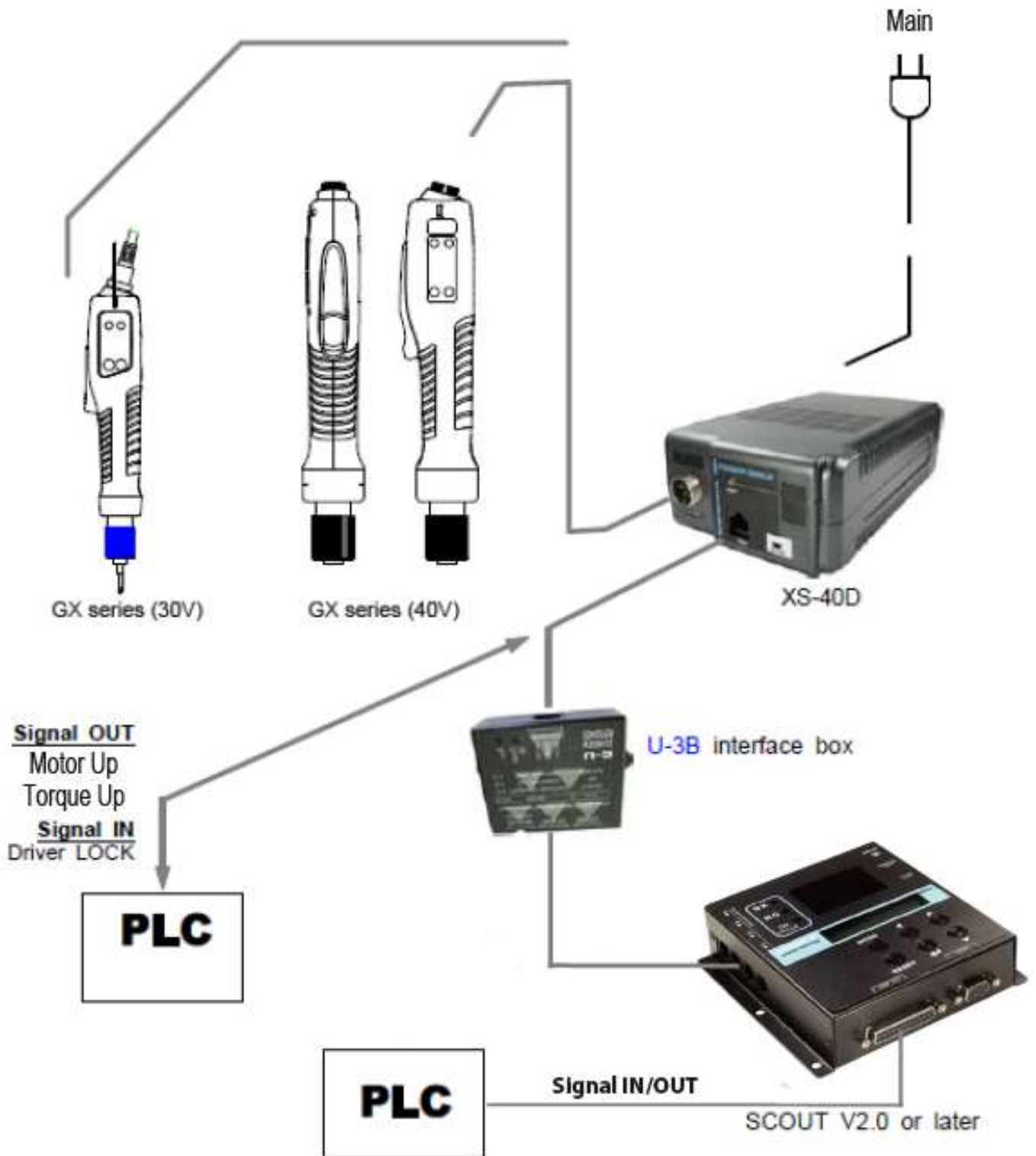

10. Interface with XS-40D controller

10-1. Connector and cables

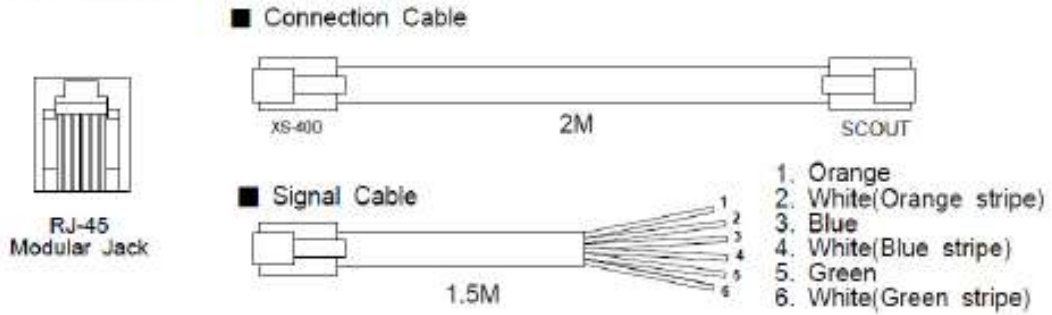

10-2. Interface for Start / Stop signal

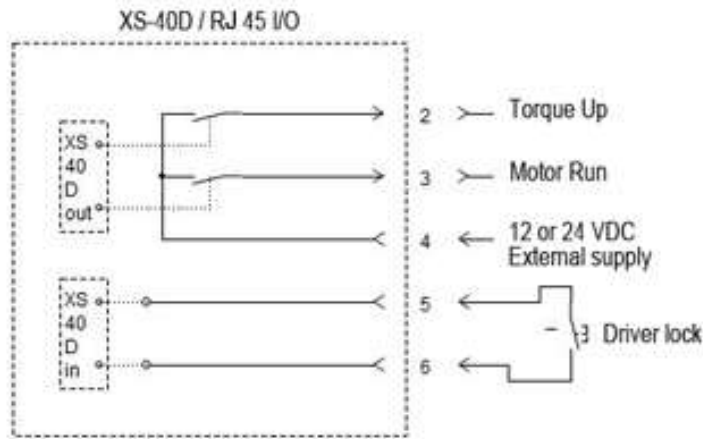

10-3. Timing chart of Start / Stop signal

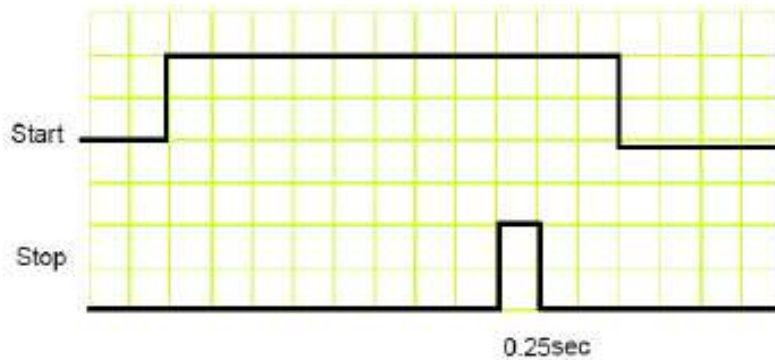

10-4. Interface converter U-3B (Option)

Interface converter converts the electronic signal by opto coupler to opposite direction as below. Also it provides additional dry contact signals in both Normal Closed and Normal Open by the built-in relay.



Interface converter U-3B (ECA5914)	
Size	75 x 60 x 28mm (h)
Weight	103gr
Opto coupler	12-24V 10mA max
Relay contact	30VDC 1A max

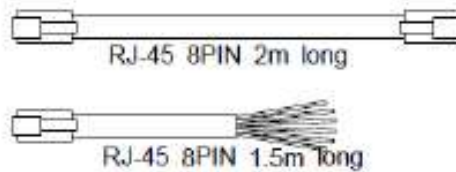
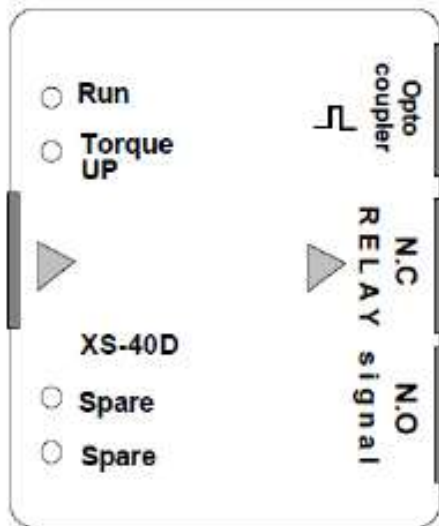

Standard accessory cables



Relay power off when not use

8PIN Configuration and Output

No	Color	Interface Signal	XS-40D	U-3B Interface converter I/O port		
				1	2	3
1	ORANGE	Spare				
2	ORANGE STRIPE	Torque Up				
3	BLUE	Motor Run				
4	BLUE STRIPE	Common for 2&3 wire				
5	GREEN	Motor Lock or Remote Start				
6	GREEN STRIPE					
7	BROWN	No use				
8	BROWN STRIPE	Spare				

U-3B interface converter I/O details

1 Opto-coupler port

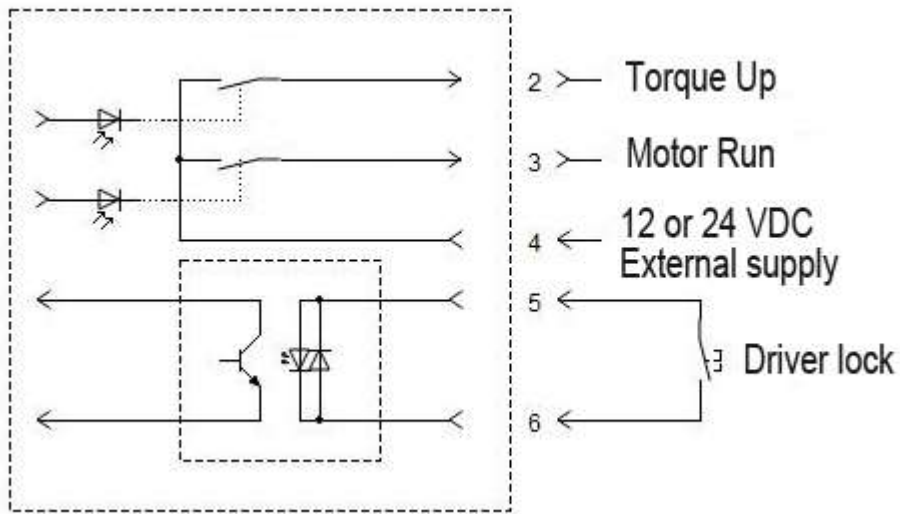

2 & 3 Relay N.C & N.O port

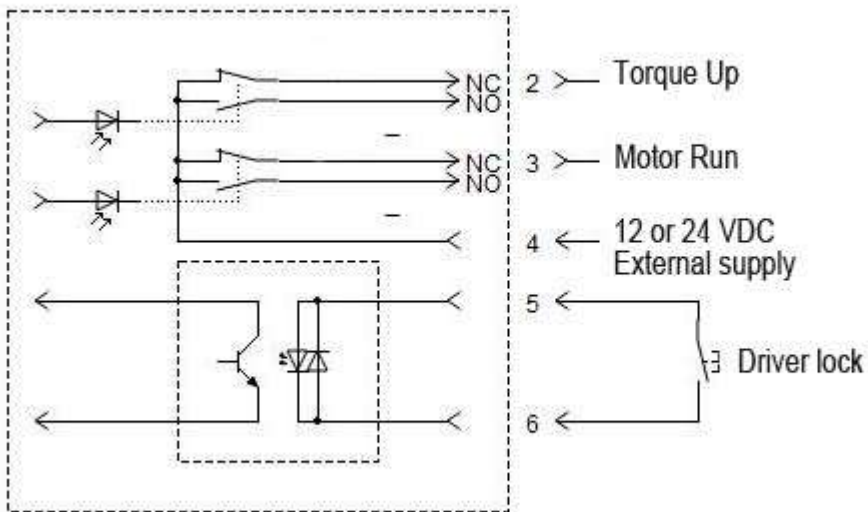

11. Interface with XS-40D FA controller

11.1 Connection and cable

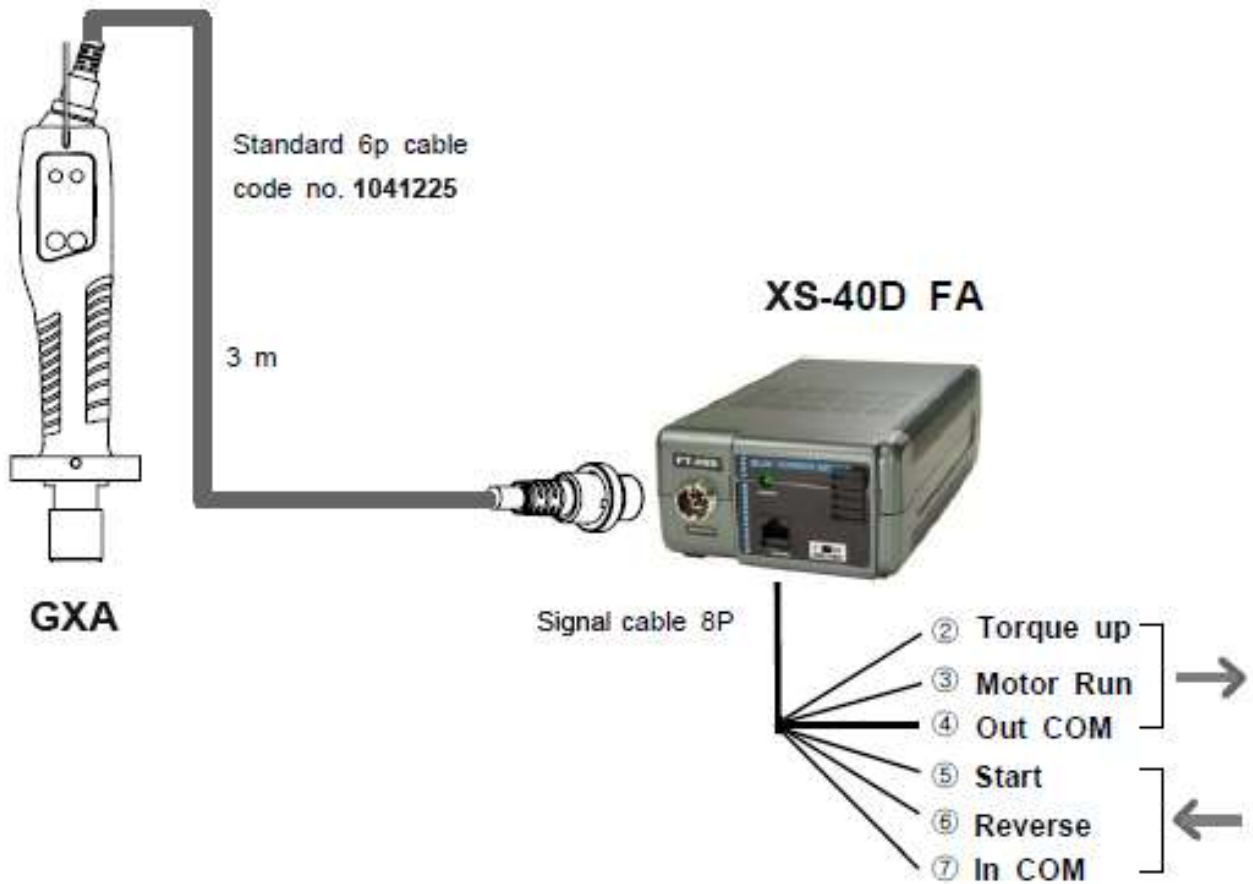

■ Signal Cable 8P (1041224)

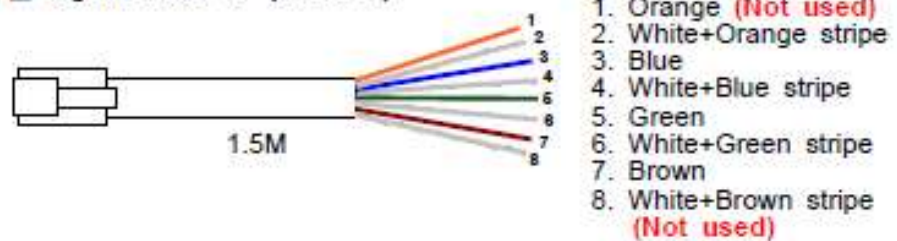

11.2 Positive(+) Common wiring

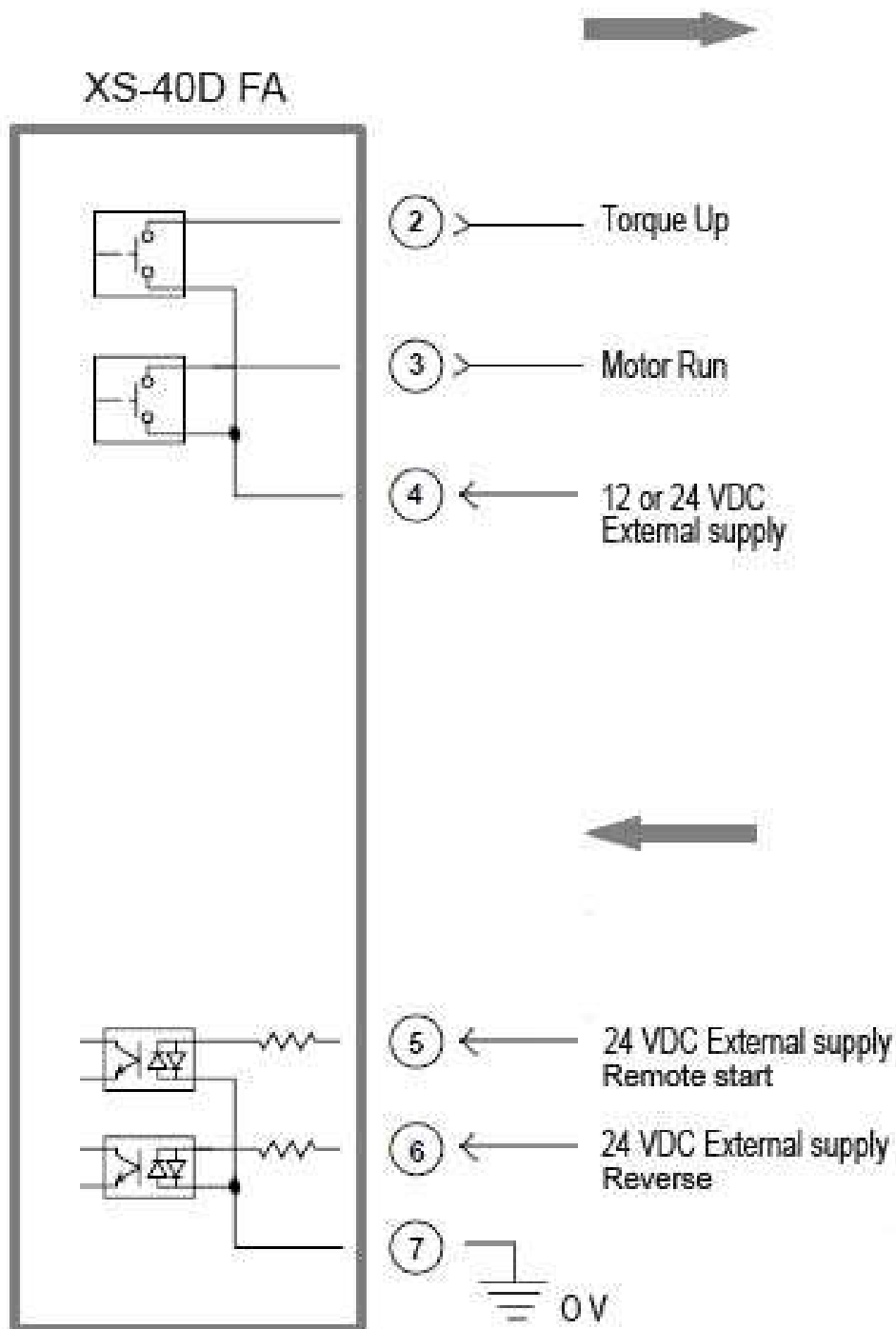

im Vertrieb von: