

DOGATEC

Mit Sicherheit montiert

Industrial Bits für die Produktion
Sonderanfertigungen auf Anfrage

INDUSTRIAL BITS



www.dogatec.de

SUMMARY

INDUSTRIAL BITS

▶ HOW TO DETERMINE THE CORRECT BITS?.....	5
▶ SCREWS SIZE	8
▶ BITS FOR PHILLIPS SCREWS	10
▶ BITS FOR POZIDRIV® SCREWS	14
▶ BITS FOR SLOTTED SCREWS	17
▶ BITS FOR SOCKET HEAD (HEX INT) SCREWS	19
▶ BITS FOR TORX® SCREWS.....	24
▶ BITS FOR TAMPER TORX®.....	28
▶ BITS FOR TORX PLUS® SCREWS.....	30
▶ BITS FOR TORX PLUS® SECURITY SCREWS	33
▶ BITS FOR SQUARE SCREWS.....	34
▶ BITS FOR AIRCRAFT SCREWS.....	35
▶ BITS FOR SPECIAL SCREWS.....	36
▶ SOCKET FOR HEXAGONAL DRIVE SCREWS.....	37
▶ MMBC RANGE BITS WITH MAGNETIC RING.....	40
▶ IMPACT RANGE BITS FOR IMPACT WRENCH AND PULSE TOOL.....	43
▶ SAFETY BITS 1 000 V	46
▶ BIT HOLDERS AND ACCESSORIES	48
▶ HAND DRIVERS	51
▶ ADAPTERS.....	52
▶ TIGHTENING TORQUE ABACUS.....	54

A WIDE RANGE OF BITS TO MEET ALL YOUR NEEDS

In this brochure, we present our range of bits.

With over 600 references, we can meet all your needs.

Our bits are made from quality materials and can be adapted to a wide range of shapes.

If you need a specific bit, we can make it to measure.

In all cases, don't hesitate to contact us.



COMPLETE RANGE

- More than 600 models of bits!
- Many references in stock.



TAILOR-MADE

- Quality tailor-made bits.
- We can meet all your requirements.



HOW TO DETERMINE THE CORRECT BITS?

1

Determine the footprint

Refer to the « Technical information » tables at the end of this documentation to define the correct footprint number.



Phillips
(N°00, 0, 1, 2 or 3)



TORX®



Hex Int



Pozidriv
(N°00, 0, 1, 2 or 3)



Tamper TORX®



Square



Slot



TORX plus®



Tri-wing



+/- in PH



TORX plus security®



Torq-Set



+/- in PZ



Triple Square (XZN)



Spanner

2

Determine the required length

Screw tightening in a well:



The length of the neckline (ℓ) must be more important than the depth of the well (Size a).



The diameter of the screwdriver bit (D) must be smaller than the diameter of the well (Size b).

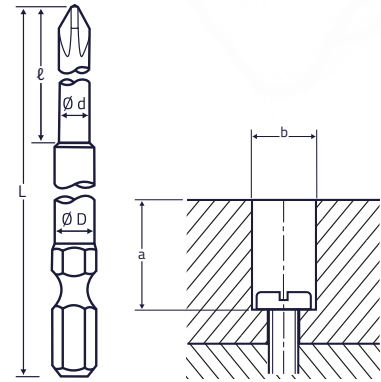

Some model has no neckline. In this case, consider the total Length (L) taking into account the Length inside the chuck (25 mm).

3

Determine the required drive

● 1/4" Hexagonal

○ C6,3

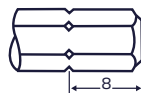

○ E6,3

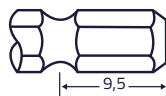

● 4 mm Half-moon

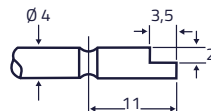

● 4 mm Wing-Shank

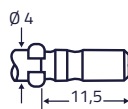

● 5/16" Hexagonal

● 3 mm Hexagonal

● Threaded (Contact us)



You have a specific need?
Contact us! info@dogatec.de

**You have a specific need for screwdriver bits?
We can supply you with tailor-made bits.**

Please complete the « Special bits questionnaire », in detail, directly on the editable PDF, and return it to your dedicated technical sales representative.

The purpose of this questionnaire is to define the bit best suited to your application.

DOGA
ASSEMBLY TECHNOLOGY

SPECIAL BITS QUESTIONNAIRE Date:

The purpose of this questionnaire is to define the characteristics of the special bit required for your application. Please complete the form accurately and return it to International@dogatec.de

Company

Service Name

Address

Zip City

Email Phone

Quantity pieces (min. 10 pieces)

Application

► Description of the application:

► Use of an automatic screw feeder: Yes No

- If yes, brand and model of the screwdriver:

A dimensioned drawing, specifying the dimensions and tolerances to be respected, is required.

© DOGA | DOC.60500.06/23 **1**

Footprint

Size	Footprint	Size
<input type="checkbox"/>	Torx plus [®]	
<input type="checkbox"/>	Hex. int (size H and unit)	
<input type="checkbox"/>	Square (1, 2, 3, 4)	
<input type="checkbox"/>	Socket for hexagonal drive screw (A/F)	
Others - to be specified		

► Ø 4 mm with wings shank (Hios)

► Ø 5 mm with wings shank (Hios)

► Ø 4 mm half-moon

► Other (to be specified)

Dimension

Nm

er HRC

ty No

ty No

© DOGA | DOC.60500.06/23 **2**

Bit - hexagonal 1/4"

Ø D (mm)		
L (mm)		

Screwdriver - hexagonal 1/4"

Ø d (mm)		Ø D (mm)	
ℓ (mm)		L (mm)	

Threaded bit

Ø M (mm)		Pas P (mm)	
Ø d (mm)		ℓ (mm)	
Ø D1 (mm)		ℓ 1 (mm)	
Ø D (mm)		ℓ 2 (mm)	
ℓ (mm)			

Threaded bit with flat spot

Ø M (mm)		Pas P (mm)	
Ø d (mm)		ℓ (mm)	
Ø D1 (mm)		ℓ 1 (mm)	
Ø D (mm)		ℓ 2 (mm)	
A (mm)		L (mm)	
B (mm)		L 1 (mm)	
ø (mm)			

Socket - hexagonal 1/4"

Ø D1 (mm)		A (mm)	
H (mm)		B (mm)	
Ø D2 (mm)		L 1 (mm)	
L (mm)		L 2 (mm)	

Magnetic socket? Yes No

© DOGA | DOC.60500.06/23

SCREWS SIZE

SLOTTED SCREWS

	Threaded stem DIN 417, 427 ISO 4766, 7435	M 2.5	M 3	M 3.5	M 4	M 5	M 6	M 8	M 10	M 12	M 14	M 16
	Footprint (mm)	2X0.4		2.5X0.4	3X0.5	4X0.8		6.5X1.2	8X1.6		10X1.6	12X2

	Threaded screw DIN 84 ISO 1580	M 1,2	M 1,4	M 1,6	M 1,8	M 2	M 2,5	M 3	M 3,5	M 4	M 5	M 6	M 8
	Footprint (mm)	2X0.4		2.5X0.4		3X0.5	3.5X0.6	4X0.8	5.5X1	6.5X1,2	8X1.2	10X1.6	12X2

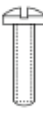
	Threaded screw DIN 85 ISO 1580	M3	M3,5	M4	M5	M6	M8
	Footprint (mm)	4X0.8	5.5X1	8X1.2		10X1.6	12X2

	Sheet metal screw DIN 7971	Ø 2.2	Ø 2.9	Ø 3.5	Ø 3.9	Ø 4.2	Ø 4.8	Ø 5.5	Ø 6.3
	Footprint (mm)	3.5X0.6	4X0.8	5.5X1		8X1.2		10X1.6	

	Sheet metal screw DIN 7972	Ø 2.2	Ø 2.9	Ø 3.5	Ø 3.9	Ø 4.2	Ø 4.8	Ø 5.5	Ø 6.3
	Footprint (mm)	3.5X0.6	4X0.8	5.5X1		6.5X1.2		10X1.6	

	Sheet metal screw DIN 7973	Ø 2.2	Ø 2.9	Ø 3.5	Ø 3.9	Ø 4.2	Ø 4.8	Ø 5.5	Ø 6.3
	Footprint (mm)	3.5X0.6	4X0.8	5.5X1		6.5X1,2	8X1.2	10X1.6	

PHILLIPS SCREWS

	Threaded screw DIN ISO 7985	M 1.5	M 1.8	M 2	M 2.5	M 3	M 3.5	M 4	M 5	M 6	M 8	M 10
	Footprint	0		1		2		3	4			

	Threaded screw DIN 965 / ISO 7987 DIN 966 / ISO 7988	M 1.5	M 1.8	M 2	M 2.5	M 3	M 3.5	M 4	M 5	M 6	M 8	M 10
	Footprint	0		1		2		3	4			

	Sheet metal screw DIN 7981 / 7982 7983	Ø 2.2	Ø 2.9	Ø 3.5	Ø 3.9	Ø 4.2	Ø 4.8	Ø 5.5	Ø 6.3
	Footprint	1		2			3		

	Threaded screw DIN 965 / ISO 7987 DIN 966 / ISO 7988	2	2.5	3	3.5	4	4.5	5	5.5	6	7	8
	Footprint	0	1		2			3			4	

METRIC SCREWS WITH INTERNAL TORX®

Footprint Torx®	 A (mm)	Metric screws with internal Torx®
T 5	1.42	≤ M 1.8
T 6	1.67	M 2
T 7	1.99	M 2
T 8	2.31	M 2.5
T 9	2.50	M 3
T 10	2.74	M 3 - M 3.5
T 15	3.27	M 3.5 - M 4
T 20	3.86	M 4 - M 5
T 25	4.43	M 4.5 - M 5
T 27	4.99	M 4.5 - M 5 - M 6
T 30	5.52	M 6 - M 7
T 40	5.65	M 7 - M 8
T 45	7.82	M 8 - M 10
T 50	8.83	M 10

HEX INT SCREWS

Footprint H (mm)	ISO 4762	ISO 1426-28	ISO 10642
1.27	M 1.4		
1.5	M 1.6 - M 2		
2	M 2.5		
2.5	M 3		
3	M 4	M 6	M 5
4	M 5	M 8	M 6
5	M 6	M 10	M 8
6	M 8	M 12 - M 14	M 10
7	M 10	-	-
8	M 10	M 16	M 12 - M 16
10	M 12	M 18 - M 20	M 14 - M 20
12	M 14	M 22 - M 24	M 18 - M 24
14	M 16 - M 18	-	M 22
17	M 20 - M 22	-	-

HEX BOLTS AND NUTS

Dimensions on flat (mm)	3.0	3.0	4.0	5.0	5.5	6.0	7.0	8.0	10	11	13	17 (ISO 16)	"19 (ISO 18)"	"22 (ISO 21)"
Screw / Nut	M 1.2	M 1.4	M 2	M 2.5	M 3	M 3.5	M 4	M 5	M 6	M 7	M 8	M 10	M 12	M 14

BITS FOR PHILLIPS SCREWS

HIOS 4 MM DRIVE

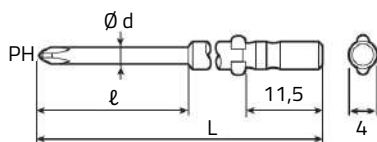

Designation	Footprint PH	Diameter d (mm)	Neckline ℓ (mm)	Length L (mm)	Code
D73 PH00X1,2X40	00	1.2	20	40	P171969
D73 PH00X1,5X40	00	1.5	20	40	P171970
D73 PH00X1,5X60	00	1.5	20	60	P171971
D73 PH00X2X40	00	2	20	40	P171972
D73 PH00X2X60	00	2	20	60	P171973
D73 PH0X1,4X40	0	1.4	20	40	P171974
D73 PH0X1,4X60	0	1.4	20	60	P171975
D73 PH0X1,7X40	0	1.7	20	40	P171976
D73 PH0X1,7X60	0	1.7	20	60	P171977
D73 PH0X2X40	0	2	20	40	P112374
D73 PH0X2X60	0	2	20	60	P171978
D73 PH0X2,5X40	0	2.5	20	40	P171979
D73 PH0X2,5X60	0	2.5	20	60	P112148
D73 PH1X3X40	1	3	20	40	P171980
D73 PH1X3X60	1	3	20	60	P108608
D73 PH1X4X40	1	4	-	40	P171981
D73 PH1X4X60	1	4	-	60	P171982
D73 PH2X4X40	2	4	-	40	P171983
D73 PH2X4X60	2	4	-	60	P171984

Sold in box of 10 pieces

HALF-MOON 4 MM DRIVE

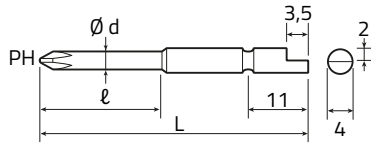

Designation	Footprint PH	Diameter d (mm)	Neckline ℓ (mm)	Length L (mm)	Code
PH00X1,5X20X44	00	1.5	20	44	P105579
PH00X1,5X20X64	00	1.5	20	64	P106684
EPH 204	00	2	20	64	P105585
EPH 202	0	1.8	20	64	P103765
PH0X2X20X44	0	2	20	44	P103381
PH0X2X20X64	0	2	20	64	P105605
EPH 205	0	2.5	20	44	P105563
EPH 206	0	2.5	20	64	P106581
EPH 207	1	3	20	44	P106595
EPH 208	1	3	20	64	P171949
EPH 209	1	4	20	44	P171948
EPH 210	1	4	-	64	P104725
EPH 211	2	4	-	44	P103417
EPH 212	2	4	-	64	P106626

Sold in box of 10 pieces

C6,3 DRIVE

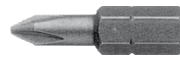
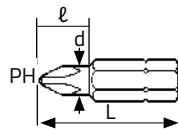

Designation	Footprint PH	Diameter d (mm)	Neckline ℓ (mm)	Length L (mm)	Code
PH00X1,5X20X44	0	3	12	25	P108407
PH00X1,5X20X64	1	4.5	12	25	P101672
EPH 204	1	7	-	25.4	P104178
EPH 201	2	5	12	25	P102629
EPH 202	2	7	-	25.4	P100752
PH0X2X20X44	3	7	-	25.4	P104745

C6,3 DRIVE - TIN COATED

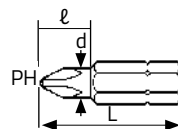

Designation	Footprint PH	Diameter d (mm)	Neckline ℓ (mm)	Length L (mm)	Code
PH1 - TiN	1	4.5	11	25	P112209
PH2 - TiN	2	6	11	25	P112253
PH3 - TiN	3	7	-	25	P124761

E6,3 DRIVE - ACCURACY MODEL

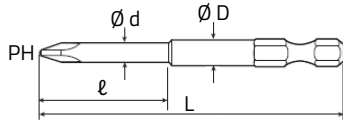

Designation	Footprint PH (mm)	Neckline d (mm)	Neckline ℓ (mm)	Diameter D (mm)	Length L (mm)	Code
PH00X1,2X20X60	00	1.2	20	7	60	P106741
PH00X1,5X20X60	00	1.5	20	7	60	P106743
PH00X1,7X20X60	00	1.7	20	7	60	P101508
PH00X2X40X60	00	2	40	7	60	P100806
PH00X2X40X100	00	2	40	7	100	P104172
PH0X1,4X30X60	0	1.4	30	7	60	P104176
PH0X1,7X30X60	0	1.7	30	7	60	P108471
PH0X1,7X40X80	0	1.7	40	7	80	P104753
PH0X2X20X60	0	2	20	7	60	P102627
PH0X2X30X100	0	2	30	7	100	P108485
PH0X2,5X20X60	0	2.5	20	7	60	P108467
PH0X2,5X30X100	0	2.5	30	7	100	P104182
PH0X3X20X60	0	3	20	7	60	P100918
PH0X3X30X100	0	3	30	7	100	P101606
1060	0	3.17	25	7	49	P100835

Sold in box of 10 pieces

E6,3 DRIVE

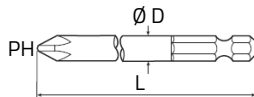

Designation	Footprint PH	Diameter D (mm)	Length L (mm)	Code
1061	1	4.76	49	P100142
1071	1	4.5	70	P100277
1081	1	4.76	89	P100842
4301/100	1	4.5	100	P101769
4301/150	1	4.5	150	P102244
1091	1	4.76	152	P103410
1062R	2	4.76	49	P100510
1062	2	6.35	49	P100138
1072	2	6.35	70	P100126
1082	2	6.35	89	P100094
4302/100	2	6	100	P100203
4302/127	2	6	127	P100184
4302/150	2	6	150	P100543
1092	2	6.35	152	P100956
4302/200	2	6	200	P100236
1063	3	8	49	P100881
1073	3	8	70	P104147
1083	3	8	89	P105570
4303/100	3	8	100	P108538

E6,3 DRIVE - TIN COATED



Designation	Footprint PH	Length L (mm)	Code
PH1X50 - TiN	1	50	P111930
PH2X50 - TiN	2	50	P112271
PH3X50 - TiN	3	50	P124764

PLUS/MINUS - H SHAPE - E6,3 DRIVE



Designation	Footprint PH	Diameter (mm)	Blade tickness (mm)	Length (mm)	Code
H1	1	4.5	0.9	73	P101385
H2	2	6	1,0	73	P102111

Sold in box of 10 pieces



Minimum depth of the footprint: 1.4 mm



BITS FOR POZIDRIV® SCREWS

HIOS 4 MM DRIVE

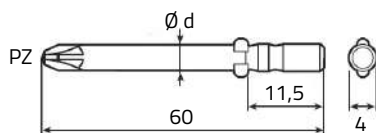

Designation	Footprint PZ	Diameter d (mm)	Length (mm)	Code
D73 PZ0X60	0	4	60	P171985
D73 PZ1X60	1	4	60	P112034
D73 PZ2X60	2	4	60	P171986

Sold in box of 10 pieces

HALF-MOON 4 MM DRIVE

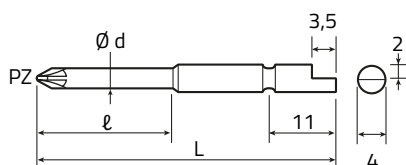

Designation	Footprint PZ	Diameter d (mm)	Neckline l (mm)	Length L (mm)	Code
D71 PZ0X44	0	2.5	20	44	P103421
D71 PZ0X64	0	2.5	20	64	P171951
D71 PZ1X44	1	4	-	44	P103109
D71 PZ1X64	1	4	-	64	P108400

Sold in box of 10 pieces

C6,3 DRIVE

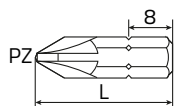

Designation	Footprint PZ	Diameter (mm)	Length L (mm)	Code
1001PZ	1	7	25.4	P100718
3001/50PZ	1	7	50	P105548
1002PZ	2	7	25.4	P100419
3002/50PZ	2	7	50	P103116
1003PZ	3	7	25.4	P101386
3003/50PZ	3	7	50	P112011

C6,3 DRIVE - TIN COATED

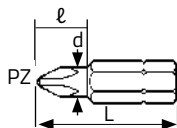

Designation	Footprint PZ	Diameter d (mm)	Neckline ℓ (mm)	Length L (mm)	Code
PZ1 - TiN	1	4.4	9	25	P100878
PZ2 - TiN	2	5.6	9	25	P100515
PZ3 - TiN	3	6	9	25	P101777

E6,3 DRIVE - ACCURACY MODEL

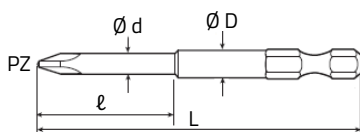

Designation	Footprint PZ	Neckline d (mm)	Neckline ℓ (mm)	Diameter D (mm)	Length L (mm)	Code
PZ0X1,4X30X60	0	1.4	30	7	60	P104804*
PZ0X2X20X60	0	2	20	7	60	P101608
PZ0X2X30X100	0	2	30	7	100	P104826*
PZ0X2,5X20X60	0	2.5	20	7	60	P104798*
PZ0X3X20X60	0	3	20	7	60	P100883
PZ0X3X30X100	0	3	30	7	100	P101976

Sold in box of 10 pieces - *Available while stocks last

In this catalogue,
all our MMBC bits
with magnetic ring



E6,3 DRIVE

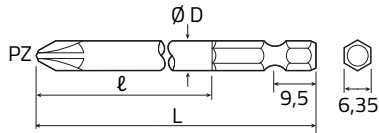

Designation	Footprint PZ	Diameter D (mm)	Neckline ℓ (mm)	Length L (mm)	Code
1061PZ	1	4.76	28	49	P100176
1071PZ	1	4.76	49	70	P100157
1081PZ	1	4.76	68	89	P100751
4301/100PZ	1	4.5	73	100	P101213
1091PZ	1	4.76	50	152	P101512
1062PZ	2	6	28	49	P100185
1072PZ	2	6	49	70	P100070
1082PZ	2	6	68	89	P100483
4302/100PZ	2	6	73	100	P100294
4302/127PZ	2	6	10	127	P101518
4302/150PZ	2	6	123	150	P100813
1092PZ	2	6.35	50	152	P101453
4302/200PZ	2	6	173	200	P104226
1063PZ	3	8	20	49	P102104
1073PZ	3	8	41	70	P101517
1083PZ	3	8	60	89	P103131
4304/51PZ	4	8	22	51	P108603

E6,3 DRIVE - TIN COATED



Designation	Footprint PZ	Length (mm)	Code
PZ1X50 - TiN	1	50	P102415
PZ2X50 - TiN	2	50	P104223
PZ3X50 - TiN	3	50	P124765

PLUS/MINUS - Z SHAPE - E6,3 DRIVE



Designation	Footprint PZ	Diameter (mm)	Blade Thickness (mm)	Length (mm)	Code
Z1	1	4.5	0.8	73	P101331
Z2	2	6	1.0	73	P100593

Sold in box of 10 pieces



Minimum depth of the footprint : 1.1 mm



BITS FOR SLOTTED SCREWS

HIOS 4 MM DRIVE

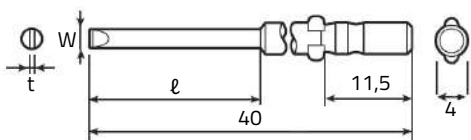

Designation	Slot thickness t (mm)	Slot width W (mm)	Neckline ℓ (mm)	Length (mm)	Code
D73 Lame 0,3X2X40	0.30	2	20	40	P106742
D73 Lame 0,3X2,5X40	0.30	2.5	20	40	P108610
D73 Lame 0,4X3X40	0.40	3	20	40	P112380
D73 Lame 0,5X4X40	0.50	4	-	40	P111948

Sold in box of 10 pieces

HALF-MOON 4 MM DRIVE

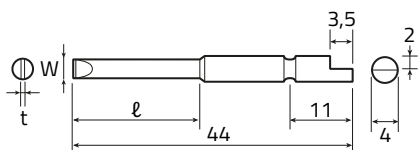

Designation	Slot thickness t (mm)	Slot width W (mm)	Neckline ℓ (mm)	Length (mm)	Code
EPL 221	0.30	2	20	44	P101506
EPL 222	0.30	2.5	20	44	P100844
EPL 223	0.40	3	20	44	P103391
EPL 224	0.50	4	-	44	P102849

Sold in box of 10 pieces

C6,3 DRIVE

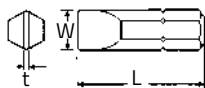

Designation	Slot thickness t (mm)	Slot width W (mm)	Length L (mm)	Code
5635/25	0.55	3.5	25	P105502
5604/25	0.6	4	25	P108438
5605/25	0.75	5	25	P106692
1501	0.86	4.76	25.4	P106733
1502	1.02	5.55	25.4	P108443
1503	1.07	6.35	25.4	P112433
1504	1.17	7.14	25.4	P171936
1505	1.27	8.00	25.4	P111993

E6,3 DRIVE

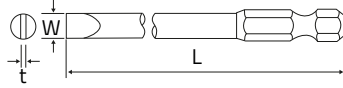

Designation	Slot thickness t (mm)	Slot width W (mm)	Length L (mm)	Code
5303/51	0.50	3.0	51	P100132
5304/51	0.60	4.0	51	P101170
152000	0.56	3.1	49	P100771
156000	0.56	3.1	76	P100629
157000	0.56	3.1	102	P101515
15200	0.66	3.4	49	P101327
15300	0.66	3.4	70	P100882
15700	0.66	3.4	102	P103380
1520	0.76	3.8	49	P101321
1560	0.76	3.8	76	P101384
1570	0.76	3.8	102	P102637
1521	0.86	4.75	49	P101158
1561	0.86	4.75	76	P101256
1571	0.86	4.75	102	P102445
1522	0.91	5.46	49	P101333
1562	0.91	5.46	76	P100957
1572	0.91	5.46	102	P101601
1524	0.97	6.35	49	P102864
1564	0.97	6.35	76	P101867
1574	0.97	6.35	102	P105594
1525	1.07	6.99	49	P102645
1565	1.07	6.99	76	P104763
1575	1.07	6.99	102	P104209
1526	1.17	7.9	49	P105399
1566	1.17	7.9	76	P103761
1576	1.17	7.9	102	P104777
1527	1.27	9.1	49	P103072
1567	1.27	9.1	76	P105586
1577	1.27	9.1	102	P108529

E6,3 DRIVE - WITH TELESCOPIC GUIDE

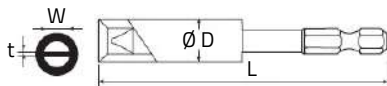

Designation	Slot thickness t (mm)	Slot width W (mm)	Diameter D (mm)	Length L (mm)	Code
6001	0.91	5	9.5	95	P101591
6002	0.97	6.12	11.1	95	P101055
6003	1.07	7	12.7	95	P102099
6004	1.17	9	14.3	95	P105437

BITS FOR SOCKET HEAD (HEX INT) SCREWS

HIOS 4 MM DRIVE

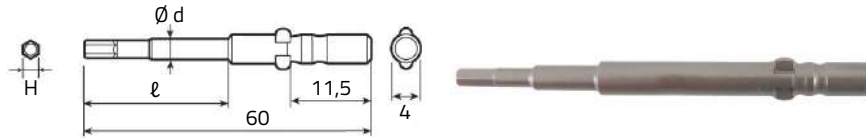

Designation	Footprint H	Diameter d (mm)	Neckline ℓ (mm)	Length L (mm)	Code
D73 H1,5X60	1.5	2	20	60	P112382
D73 H2X60	2	3	20	60	P171987
D73 H2,5X60	2.5	3	20	60	P112152
D73 H3X60	3	4	-	60	P112384

Sold in box of 10 pieces

HALF-MOON 4 MM DRIVE



Designation	Footprint H	Diameter d (mm)	Neckline ℓ (mm)	Length L (mm)	Code
EHW 231	1.5	3	20	44	P103393
EHW 232	2	3	20	44	P108396
EHW 233	2.5	3.5	20	44	P106686
EHW 234	3	4	20	44	P108502

Sold in box of 10 pieces

C6,3 DRIVE - INCH UNIT

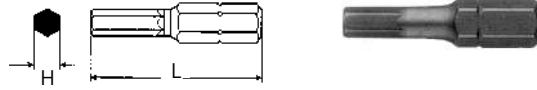

Designation	Footprint H (")	Length L (mm)	Code
H0,05" L.25	0,05"	25	P106559
H1/16" L.25	1/16"	25	P106453
H5/64" L.25	5/64"	25	P105412
H3/32" L.25	3/32"	25	P105461
H7/64" L.25	7/64"	25	P105427
H1/8" L.25	1/8"	25	P170560
H9/64" L.25	9/64"	25	P111566
H5/32" L.25	5/32"	25	P170561
H3/16" L.25	3/16"	25	P170562
H7/32" L.25	7/32"	25	P170563
H1/4" L.25	1/4"	25	P111587
H5/16" L.25	5/16"	25	P110755
H3/8" L.25	3/8"	25	P170564

C6,3 DRIVE - METRIC UNIT

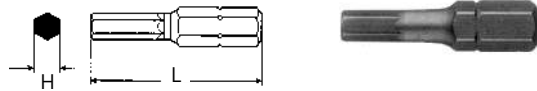

Designation	Footprint H (mm)	Length L (mm)	Code
30315/25	1.5	25	P102442
3032/25	2	25	P100885
30325/25	2.5	25	P100807
3033/25	3	25	P100563
3034/25	4	25	P100464
21004	4	33.3	P104742
3035/25	5	25	P100925
21005	5	33.3	P102247
3036/25	6	25	P100840
21006	6	33.3	P104739
3038/25	8	25	P102123
21008	8	31.8	P106735

C6,3 DRIVE - SPHERICAL MODELS

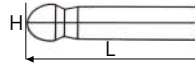

Designation	Footprint H (mm)	Length L (mm)	Code
3720/25	2	25	P105447
3725/25	2.5	25	P111020
3730/25	3	25	P103069
3740/25	4	25	P102239
3750/25	5	25	P102613
3760/25	6	25	P103724
3780/25	8	25	P106504

Sold in box of 10 pieces

E6,3 DRIVE - INCH UNIT

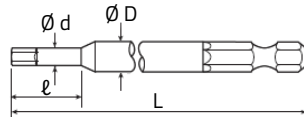

Designation	Footprint H (")	Diameter d (mm)	Length L (mm)	Code
H0,05" L.50	0,05"	2.5	50	P101979
H1/16" L.50	1/16"	2.5	50	P104141
H5/64" L.50	5/64"	3.0	50	P102238
H3/32" L.50	3/32"	3.0	50	P102097
H7/64" L.50	7/64"	3.5	50	P103716
H1/8" L.50	1/8"	4.0	50	P106495
H9/64" L.50	9/64"	4.5	50	P104702
H5/32" L.50	5/32"	5.0	50	P103353
H3/16" L.50	3/16"	6.0	50	P105394
H7/32" L.50	7/32"	-	50	P111191
H1/4" L.50	1/4"	-	50	P104151
H5/16" L.50	5/16"	-	50	P108131

Sold in box of 10 pieces

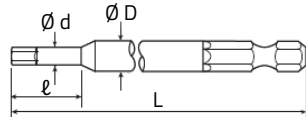

Designation	Footprint H (mm)	Neckline d (mm)	Neckline ℓ (mm)	Diameter D (mm)	Length L (mm)	Code
H1,5X50	1.5	-	-	-	50	P100336
21202	2	-	-	7	49	P100444
H2X75	2	2.3	10	7	75	P100204
H2X100	2	2.3	10	7	100	P101451
H2X150	2	2.3	10	7	150	P101855
21225	2.5	3.5	27	7	49	P100141
H2,5X75	2.5	3	10	7	75	P100227
H2,5X100	2.5	3	10	7	100	P101004
H2,5X150	2.5	3	10	7	150	P100542
21203	3	3.6	27	7	49	P100211
H3X75	3	3.6	10	7	75	P100240
H3X100	3	3.6	10	7	100	P100804
H3X150	3	3.6	10	7	150	P100300
21204	4	4.7	27	7	49	P100129
H4X75	4	4.7	11	7	75	P100158
H4X100	4	4.7	11	7	100	P100412
H4X150	4	4.7	11	7	150	P100334
21205	5	5.8	27	7	49	P100197
H5X75	5	5.8	14	7	75	P100249
H5X100	5	5.8	14	7	100	P100775
H5X150	5	5.8	14	7	150	P100427
21206	6	-	-	7	49	P100674
H6X75	6	-	-	7	75	P100513
H6X100	6	-	-	7	100	P100959
H6X150	6	-	-	7	150	P100372
1337/70	7	8.1	15	10	70	P105600
1338/70	8	9.2	15	10	70	P100432
H8X150	8	9.2	19	10	150	P100311
1339/70	9	-	-	11	70	P105472
1340/70	10	-	-	12	70	P102868
H10X150	10	-	-	12	150	P101969



Designation	Footprint H (mm)	Length (mm)	Code
1732/50	2	50	P103081
17325/50	2.5	50	P103071
1733/50	3	50	P101592
1734/50	4	50	P101505
1735/50	5	50	P101255
1736/50	6	50	P101379
1738/50	8	50	P102831

Sold in box of 10 pieces

In this catalogue,
you will find our
IMPACT bits for use
with impact screwdrivers
or impulse screwdrivers



BITS FOR TORX® SCREWS

HIOS 4 MM DRIVE

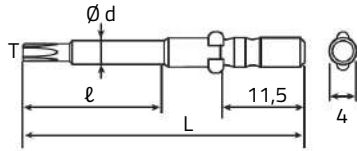

Designation	Footprint T	Diameter d (mm)	Neckline l (mm)	Length L (mm)	Code
D73 T1X40	1	1.5	20	40	P171988
D73 T2X40	2	1.5	20	40	P171989
D73 T3X40	3	1.7	20	40	P171990
D73 T4X40	4	1.8	20	40	P171991
D73 T5X40	5	2	20	40	P171992
D73 T5X60	5	2	20	40	P106654
D73 T6X40	6	2.5	20	40	P112386
D73 T6X60	6	2	20	40	P106744
D73 T7X60	7	2	20	40	P171993
D73 T8X40	8	2.5	20	40	P108426
D73 T9X40	9	3	20	40	P111978
D73 T10X40	10	3	20	40	P112390

Sold in box of 10 pieces

HALF-MOON 4 MM DRIVE

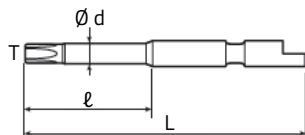

Designation	Footprint T	Diameter d (mm)	Neckline l (mm)	Length L (mm)	Code
D71 T1X44	1	1.5	20	44	P171952
D71 T2X44	2	1.5	20	44	P112000
D71 T3X44	3	1.7	20	44	P101870
D71 T4X44	4	1.8	20	44	P112082
ETX250	5	2	6.5	44	P103763
ETX251	5	2	6.5	64	P105547
ETX252	6	2	6.5	44	P101317
ETX253	6	2	6.5	64	P101452
D71 T7X44	7	2.5	20	44	P105539
D71 T8X44	8	3	20	44	P103119
D71 T9X44	9	3	20	44	P106602

Sold in box of 10 pieces

C6,3 DRIVE

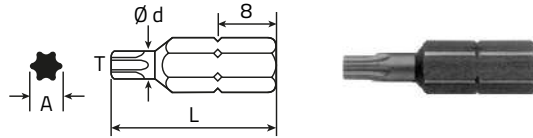

Designation	Footprint T	Size A (mm)	Neckline d (mm)	Length L (mm)	Code
T03/25	3	1.12	1.14	25	P112239
T05/25	5	1.37	1.67	25	P102855
T06/25	6	1.35	1.95	25	P100399
T07/25	7	1.99	2.27	25	P103398
T08/25	8	2.31	2.60	25	P101065
T09/25	9	2.50	2.78	25	P102628
T10/25	10	2.74	3.02	25	P100484
T15/25	15	3.27	3.56	25	P102103
T20/25	20	3.86	4.14	25	P100400
T25/25	25	4.43	4.70	25	P101261
T27/25	27	4.99	5.26	25	P106636
T30/25	30	5.52	5.79	25	P101113
T40/25	40	6.30	-	25	P103092
T45/25	45	7.85	-	25	P111924

C6,3 DRIVE - TIN COATED

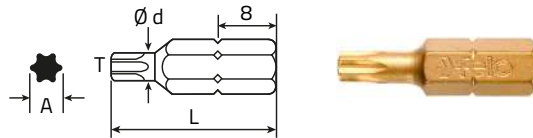

Designation	Footprint T	Size A (mm)	Length L (mm)	Code
Torx 10 - TiN	10	2.74	25	P101864
Torx 15 - TiN	15	3.27	25	P100920
Torx 20 - TiN	20	3.86	25	P101109
Torx 25 - TiN	25	4.43	25	P101516
Torx 27 - TiN	27	4.99	25	P124762
Torx 30 - TiN	30	5.52	25	P103733
Torx 40 - TiN	40	6.30	25	P124763
Torx 45 - TiN	45	7.85	25	P124766

In this catalogue,
all our MMBC bits
with magnetic ring



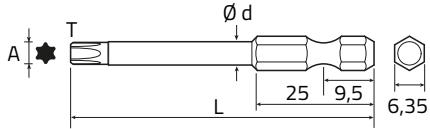

Designation	Footprint T	Size A (mm)	Neckline d (mm)	Length L (mm)	Code
Torx 1 L.50	1	0,84	2	50	P106583
Torx 2 L.50	2	0,94	2	50	P106634
Torx 3 L.50	3	1,12	2	50	P102117
Torx 4 L.50	4	1,30	2	50	P101775
T10605	5	1,37	3,18	49	P100838
T10705	5	1,37	3,18	70	P101521
T10805	5	1,37	3,18	90	P107374
T10606	6	1,65	3,18	49	P100073
T10706	6	1,65	3,18	70	P100214
T10806	6	1,65	3,18	90	P100675
T10906	6	1,65	3,18	152	P102446
T10607	7	1,99	3,18	49	P101329
T10707	7	1,99	3,18	70	P101393
T10807	7	1,99	3,18	90	P102643
T10907	7	1,99	3,18	152	P101390
T10608	8	2,31	3,18	49	P100177
T10708	8	2,31	3,18	70	P100207
T10808	8	2,31	3,18	90	P100226
T10908	8	2,31	3,18	152	P101059
T10609	9	2,50	3,18	49	P100958
T10709	9	2,50	3,18	70	P103107
T10809	9	2,50	3,18	90	P103110
T10909	9	2,50	3,18	152	P108531
T10610	10	2,74	3,96	49	P100143
T10710	10	2,74	3,96	70	P100101
T10810	10	2,74	3,96	90	P100099
T10910	10	2,74	3,96	152	P100251
T10615	15	3,27	3,96	49	P100733
T10715	15	3,27	3,96	70	P100503
T10815	15	3,27	3,96	90	P100676
T10915	15	3,27	3,96	152	P101063
T10620	20	3,86	4,75	49	P100144
T10720	20	3,86	4,75	70	P100113
T10820	20	3,86	4,75	90	P100095
T10920	20	3,86	4,75	152	P100318
T10625	25	4,43	4,75	49	P100386
T10725	25	4,43	4,75	70	P100473
T10825	25	4,43	4,70	90	P100532
T10925	25	4,43	4,75	152	P100530
T10627	27	4,99	6,35	49	P103412
T10827	27	4,99	6,35	90	P105530
T10927	27	4,99	6,35	152	P111928
T10630	30	5,52	6,35	49	P100632
T10730	30	5,52	6,35	70	P100565
T10830	30	5,52	6,35	90	P100843
T10930	30	5,52	6,35	152	P101383

E6,3 DRIVE

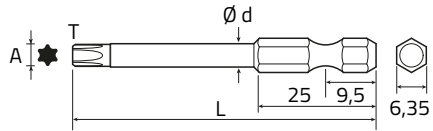

Designation	Footprint T	Size A (mm)	Neckline d (mm)	Length L (mm)	Code
T10640	40	6.65	7	49	P102426
T10740	40	6.65	7	70	P103736
T10840	40	6.65	7	90	P171947
T10940	40	6.65	7	152	P105471

BITS FOR TAMPER TORX®

HIOS 4 MM DRIVE

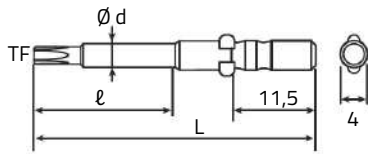

Designation	Footprint TF	Diameter d (mm)	Length L (mm)	Code
D73 T8HX60	8	4	60	P171994
D73 T10HX60	10	4	60	P171995

Sold in box of 10 pieces

HALF-MOON 4 MM DRIVE

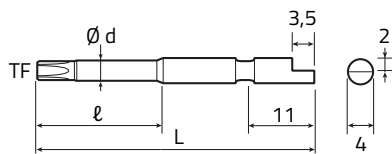

Designation	Footprint TF	Diameter d (mm)	Neckline l (mm)	Length L (mm)	Code
ETX254	8	3	2.0	44	P171966
ETX255	8	3	48	64	P112344
ETX256	10	3	7.5	44	P108480
ETX257	10	3	7.5	64	P112026
ETX259	15	4	7.5	64	P171967

Sold in box of 10 pieces

C6,3 DRIVE

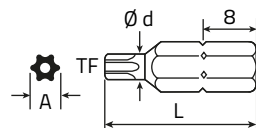

Designation	Footprint TF	Size A (mm)	Neckline d (mm)	Length L (mm)	Code
TF08/25	8	2.31	2.60	25	P101971
TF09/25	9	2.50	2.78	25	P111995
TF10/25	10	2.74	3.02	25	P104191
TF15/25	15	3.27	3.56	25	P106710
TF20/25	20	3.86	4.14	25	P102641
TF25/25	25	4.43	4.70	25	P104217
TF27/25	27	4.99	5.26	25	P171953
TF30/25	30	5.52	5.79	25	P105535

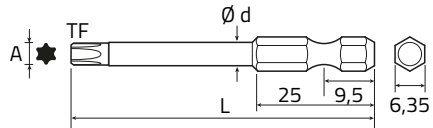

Designation	Footprint TF	Size A (mm)	Neckline d (mm)	Length L (mm)	Code
T10610H	10	2.74	3.96	49	P103423
T10710H	10	2.74	3.96	70	P101454
T10620H	20	3.86	4.75	49	P101984
T10720H	20	3.86	4.75	70	P103753
T10820H	20	3.86	4.75	90	P102841
T10920H	20	3.86	4.75	152	P106729

BITS FOR TORX PLUS® SCREWS

HIOS 4 MM DRIVE

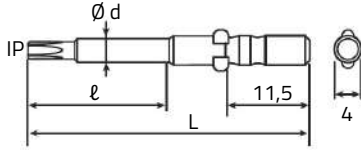

Designation	Footprint IP	Diameter d (mm)	Neckline l (mm)	Length L (mm)	Code
D73 4IPx60	4	1.8	20	60	P171996
D73 5IPx60	5	2	20	60	P171997
D73 6IPx60	6	2.5	20	60	P171998
D73 8IPx60	8	3	20	60	P171999
D73 10IPx60	10	3	20	60	P112156

Sold in box of 10 pieces

HALF-MOON 4 MM DRIVE

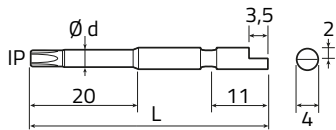

Designation	Footprint IP	Diameter d (mm)	Neckline (mm)	Length L (mm)	Code
D71 2IPx44	2	1.5	20	44	P171962
D71 2IPx64	2	1.5	20	64	P112122
D71 3IPx44	3	1.7	20	44	P106587
D71 3IPx64	3	1.7	20	64	P111970
D71 4IPx44	4	1.8	20	44	P108592
D71 4IPx64	4	1.8	20	64	P171963
D71 5IPx44	5	2	20	44	P112124
D71 5IPx64	5	2	20	64	P106734
D71 6IPx44	6	2.5	20	44	P112022
D71 6IPx64	6	2.5	20	64	P112330
D71 8IPx44	8	3	20	44	P112126
D71 8IPx64	8	3	20	64	P112332
D71 10IPx44	10	3	20	44	P111932
D71 10IPx64	10	3	20	64	P112334

Sold in box of 10 pieces

C6,3 DRIVE

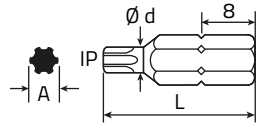

Designation	Footprint IP	Size A (mm)	Neckline d (mm)	Length L (mm)	Code
6IP/25	6	1.64	1.95	25	P103747
8IP/25	8	2.31	2.60	25	P106718
10IP/25	10	2.72	3.02	25	P106642
15IP/25	15	3.25	3.56	25	P171954
20IP/25	20	3.84	4.14	25	P108569
25IP/25	25	4.39	4.70	25	P108376
30IP/25	30	5.49	5.79	25	P112290
40IP/25	40	6.30	-	25	P105591

Sold in box of 10 pieces

E6,3 DRIVE

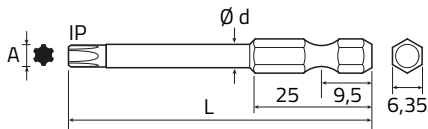

Designation	Footprint IP	Size A (mm)	Neckline d (mm)	Length L (mm)	Code
IP10605	5	1.41	3.18	49	P104225
IP10705	5	1.41	3.18	70	P112296
IP10606	6	1.64	3.18	49	P101866
IP10706	6	1.64	3.18	70	P102845
IP10806	6	1.64	3.18	90	P103764
IP10906	6	1.64	3.18	152	P106728
IP10608	8	2.31	3.18	49	P101387
IP10708	8	2.31	3.18	70	P103111
IP10808	8	2.31	3.18	90	P104227
IP10908	8	2.31	3.18	152	P106606
IP10610	10	2.74	3.96	49	P103387
IP10710	10	2.74	3.96	70	P102640
IP10810	10	2.74	3.96	90	P106726
IP10910	10	2.74	3.96	152	P103768
IP10615	15	3.27	3.96	49	P171955
IP10715	15	3.27	3.96	70	P105536
IP10815	15	3.27	3.96	90	P106646
IP10915	15	3.27	3.96	152	P105468
IP10620	20	3.86	4.75	49	P103755
IP10720	20	3.86	4.75	70	P103373
IP10820	20	3.86	4.75	90	P102261
IP10920	20	3.86	4.75	152	P106648
IP10625	25	4,43	4.75	49	P108470
IP10725	25	4,43	4.75	70	P105538
IP10825	25	4,43	4.75	90	P108584
IP10925	25	4,43	4.75	152	P104169

Sold in box of 10 pieces

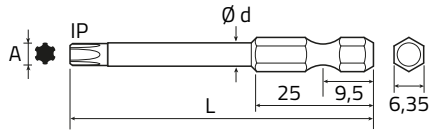

Designation	Footprint IP	Size A (mm)	Neckline d (mm)	Length L (mm)	Code
IP10627	27	4.99	6.35	49	P171956
IP10630	30	5.52	6.35	49	P104752
IP10730	30	5.52	6.35	70	P106571
IP10830	30	5.52	6.35	90	P171958
IP10930	30	5.52	6.35	152	P171960
IP10640	40	6.65	8	49	P106722
IP10740	40	6.65	8	70	P171957
IP10840	40	6.65	8	90	P171959
IP10940	40	6.65	8	152	P171961

Sold in box of 10 pieces

BITS FOR TORX PLUS® SECURITY SCREWS

C6,3 DRIVE

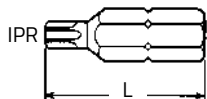

Designation	Footprint IPR	Length L (mm)	Code
8IPR L.25	8	25	P111553
9IPR L.25	9	25	P170565
10IPR L.25	10	25	P170566
15IPR L.25	15	25	P170567
20IPR L.25	20	25	P105438
25IPR L.25	25	25	P170568
27IPR L.25	27	25	P170569
30IPR L.25	30	25	P106476
40IPR L.35	40	35	P170570
45IPR L.35	45	35	P170571

Sold in box of 10 pieces

E6,3 DRIVE



Designation	Footprint IPR	Diameter (mm)	Length (mm)	Code
10IPR L.50	10	4.0	50	P108223
15IPR L.50	15	4.0	50	P108310
20IPR L.50	20	4.5	50	P103068
25IPR L.50	25	6.0	50	P108145
27IPR L.50	27	6.0	50	P170572
30IPR L.50	30	6.0	50	P111179

Sold in box of 10 pieces



These screwdrivers bits are only sold to customer under
"TORX PLUS TAMPER-RESISTANT" user licence

BITS FOR SQUARE SCREWS

C6,3 DRIVE

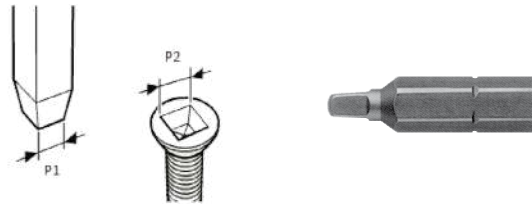

Designation	Footprint P (")	P1 (mm)	P2 (mm)	Length (mm)	Code
3001	1 (3/32")	2.31	2.5	25.4	P171931
3002	2 (1/8")	2.85	3.1	25.4	P104772
3003	3 (9/64")	3.37	3.7	25.4	P171932

Sold in box of 10 pieces

E6,3 DRIVE

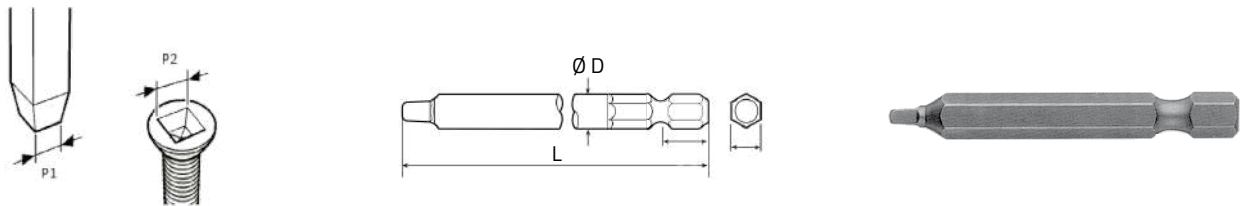

Designation	Footprint P (")	P1 (mm)	P2 (mm)	Neckline D (mm)	Length L (mm)	Code
3041	1 (3/32")	2.31	2.5	4.76	70	P103742
3042	2 (1/8")	2.85	3.1	6.35	70	P101212
3043	3 (9/64")	3.37	3.7	8	70	P171930

Sold in box of 10 pieces

In this catalogue, you will find our **IMPACTOR** bits for use with impact screwdrivers or impulse screwdrivers



BITS FOR AIRCRAFT SCREWS

TRI-WING® - C6,3 DRIVE

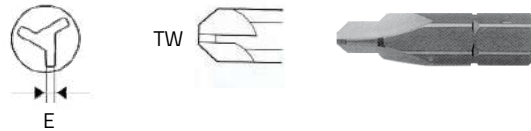

Designation	Footprint TW	Dimension E (mm)	Length (mm)	Code
4001	1	0.57	25.4	P111971
4002	2	0.75	25.4	P171933
4003	3	0.95	25.4	P171934
4004	4	1.08	25.4	P171935

Sold in box of 10 pieces

TRI-WING® - E6,3 DRIVE

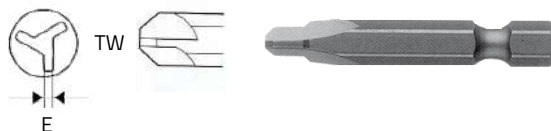

Designation	Footprint TW	Dimension E (mm)	Length (mm)	Code
B39 TW2	2	0.75	40	P172003
B39 TW3	3	0.95	40	P112420
B39 TW4	4	1.08	40	P111982
B39 TW5	5	1.23	40	P172004

Sold in box of 10 pieces

TORQ-SET® - C6,3 DRIVE



Designation	Footprint TS	Dimension E (mm)	Length (mm)	Code
212-0	0	0.43	25.4	P170554
212-1	1	0.43	25.4	P112013
212-2	2	0.43	25.4	P170555
212-3	3	0.48	25.4	P112015
212-4	4	0.56	25.4	P106739
212-5	5	0.63	25.4	P112019
212-6	6	0.71	25.4	P170556
212-8	8	0.84	25.4	P112021
212-10	10	0.96	25.4	P170557
212-1/4	1/4	1.27	25.4	P170558

Sold by 5 pieces

BITS FOR SPECIAL SCREWS

TRIPLE SQUARE (XZN) - C6,3 DRIVE

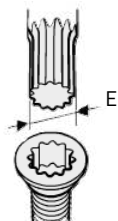

Designation	Dimension E (mm)	Length (mm)	Code
XZN M4	3.83	26	P112379
XZN M5	4.80	26	P112381
XZN M6	6.00	26	P108434
XZN M8	7.20	26	P108506
XZN M10	9.60	26	P124760

SPANNER® - C6,3 DRIVE

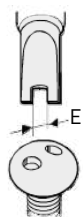

Designation	Dimension E	Diameter (mm)	Length (mm)	Code
Spanner 6	2.41	4.3	26	P112079
Spanner 8	2.79	5.2	26	P108491
Spanner 10	3.30	6.1	26	P108493

SOCKET FOR HEXAGONAL DRIVE SCREWS

E6,3 DRIVE

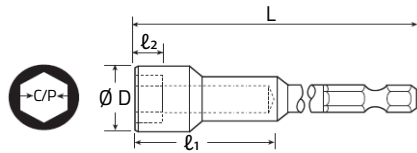

Designation	Footprint C/P (mm)	Diameter D (mm)	Depth l_1 (mm)	Depth l_2 (mm)	Length L (mm)	Code
1304/50	4	8	15	3	50	P101780
1304/75	4	8	25	3	75	P104200
1304/100	4	8	25	3	100	P108554
1345/50	4,5	8	15	3	50	P105511
1345/75	4,5	8	25	3	75	P105577
1345/100	4,5	8	25	3	100	P112226
1305/50	5	8,5	15	3,5	50	P101219
1305/75	5	8,5	25	3,5	75	P102854
1305/100	5	8,5	25	3,5	100	P108556
1305/150	5	8,5	25	3,5	150	P108562
1355/50	5,5	9	15	3,5	50	P100577
1355/75	5,5	9	25	3,5	75	P101681
1355/100	5,5	9	25	3,5	100	P102632
1355/150	5,5	9	25	3,5	150	P104814
1306/50	6	10	15	4	50	P101991
1306/75	6	10	25	4	75	P105597
1306/100	6	10	25	4	100	P103785
1306/150	6	10	25	4	150	P105486
1307/50	7	13	15	5	50	P100591
1307/75	7	13	25	5	75	P100810
1307/100	7	13	25	5	100	P101442
1307/150	7	13	25	5	150	P102106
1308/50	8	13	15	5	50	P100380
1308/75	8	13	25	5	75	P100809
1308/100	8	13	22	6,5	100	P180581
1308/150	8	13	25	5	150	P101108
1309/50	9	14	15	5,5	50	P105537
1309/75	9	14	30	5,5	75	P103404
1309/100	9	14	30	5,5	100	P108560
1310/50	10	16	15	6,5	50	P100202
1310/75	10	16	22	6,5	75	P100457
1310/100	10	16	30	6,5	100	P100999
1310/150	10	16	30	6,5	150	P100774
1311/50	11	17	15	7	50	P106579
1311/75	11	17	30	7	75	P104794
1311/100	11	17	30	7	100	P112234

E6,3 DRIVE - Suite

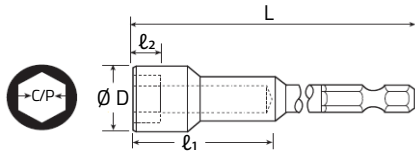

Designation	Footprint C/P (mm)	Diameter D (mm)	Depth l_1 (mm)	Depth l_2 (mm)	Length L (mm)	Code
1312/50	12	19	15	7.5	50	P106670
1312/75	12	18	30	7.5	75	P112218
1312/100	12	18	30	7.5	100	P106696
1312/150	12	18	30	7.5	150	P171946
1313/50	13	19	15	8	50	P100433
1313/75	13	19	30	8	75	P100916
1313/100	13	19	30	8	100	P101381
1313/150	13	19	30	8	150	P101678
1314/50	14	20	15	8	50	P102441
1314/75	14	20	30	8	75	P103741
1314/100	14	20	30	8	100	P111421

HALF-MOON 4 MM DRIVE

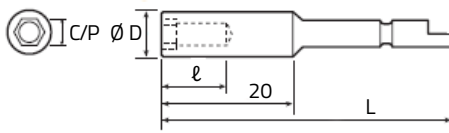

Designation	Footprint C/P (mm)	Diameter D (mm)	Depth l (mm)	Length L (mm)	Code
EBX 241	2.3	4	5	44	P171950
EBX 242	2.5	4	5	44	P112347
EBX 243	3	5	8	44	P104228
EBX 244	4	7	10	44	P105573
EBX 245	4.5	7	10	44	P112375
EBX 246	5	8	15	44	P105575
EBX 247	5.5	8	15	44	P108430

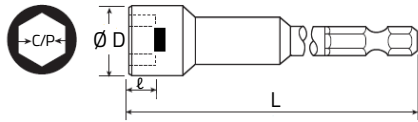

Designation	Footprint C/P (mm)	Diameter D (mm)	Depth l (mm)	Length L (mm)	Code
1305/50M	5	8.5	3.5	50	P104830
1305/75M	5	8.5	3.5	75	P105501
1305/100M	5	8.5	3.5	100	P105603
1305/150M	5	8.5	3.5	150	P103751
1355/50M	5.5	9	3.5	50	P103427
1355/75M	5.5	9	3.5	75	P102263
1355/100M	5.5	9	3.5	100	P104760
1355/150M	5.5	9	3.5	150	P101214
1306/50M	6	10	4	50	P106614
1306/75M	6	10	4	75	P171940
1306/100M	6	10	4	100	P112135
1306/150M	6	10	4	150	P104190
1307/50M	7	13	4.5	50	P101323
1307/75M	7	13	4.5	75	P102252
1307/100M	7	13	4.5	100	P101778
1307/150M	7	13	5	150	P101687
1308/50M	8	13	5	50	P100734
1308/75M	8	13	5	75	P101006
1308/100M	8	13	5	100	P100921
1308/150M	8	13.5	3.17	150	P108534
1309/50M	9	14	5.5	50	P171937
1309/75M	9	14	5.5	75	P108515
1309/100M	9	14	5.5	100	P171942
1310/50M	10	16	6.5	50	P100808
1310/75M	10	16	6.5	75	P100655
1310/100M	10	16	6.5	100	P101450
1310/150M	10	16	6.5	150	P101159
1311/50M	11	17	7	50	P171938
1311/75M	11	17	7	75	P108517
1311/100M	11	17	7	100	P112143
1312/50M	12	19	7.5	50	P171939
1312/75M	12	18	7.5	75	P112127
1312/100M	12	18	7.5	100	P171943
1312/150M	12	18	7.5	150	P171945
1313/50M	13	19	8	50	P101982
1313/75M	13	19	8	75	P101858
1313/100M	13	19	8	100	P101677
1313/150M	13	19	8	150	P103105
1314/50M	14	20	8	50	P106664
1314/75M	14	20	8	75	P171941
1314/100M	14	20	8	100	P171944

MMBC RANGE

BITS WITH MAGNETIC RING

PHILLIPS MMBC - C6,3 DRIVE



Designation	Footprint PH	Diameter (mm)	Length (mm)	Code
PH1 L.33MMBC	1	12	33	P102425
PH2 L.33MMBC	2	12	33	P101332

Sold in box of 10 pieces

PHILLIPS MMBC - SPARE BITS (WITHOUT RING)



Designation	Footprint PH	Neckline (mm)	Length (mm)	Code
PH1 L.33MMBC	1	4.5	33	P101868
PH2 L.33MMBC	2	4.5	33	P101603

Sold in box of 10 pieces

POZIDRIV® MMBC - C6,3 DRIVE



Designation	Footprint PZ	Diameter (mm)	Length (mm)	Code
PZ1 L.33MMBC	1	12	33	P103730
PZ2 L.33MMBC	2	12	33	P100811

Sold in box of 10 pieces

POZIDRIV® MMBC - SPARE BITS (WITHOUT RING)



Designation	Footprint PZ	Neckline (mm)	Length (mm)	Code
PZ1 L.33	1	4.5	33	P171968
PZ2 L.33	2	4.5	33	P102125

Sold in box of 10 pieces

TORX® MMBC - C6,3 DRIVE



Designation	Footprint T	Diameter (mm)	Length (mm)	Code
T10 L.33MMBC	10	12	33	P104758
T15 L.33MMBC	15	12	33	P102646
T20 L.33MMBC	20	12	33	P100136
T25 L.33MMBC	25	12	33	P100304

Sold in box of 10 pieces

TORX® MMBC - SPARE BITS (WITHOUT RING)



Designation	Footprint T	Neckline (mm)	Length (mm)	Code
T10 L.33	10	3.02	33	P104231
T15 L.33	15	3.56	33	P171965
T20 L.33	20	4.5	33	P101062
T25 L.33	25	4.55	33	P101510

Sold in box of 10 pieces

TORX® MMBC - E6,3 DRIVE



Designation	Footprint T	Length (mm)	Code
T10 L.49MMBC	10	49	P100917
T10 L.70MMBC	10	70	P103096
T15 L.49MMBC	15	49	P100919
T15 L.70MMBC	15	70	P102839
T20 L.49MMBC	20	49	P100078
T20 L.75MMBC	20	75	P100033
T20 L.150MMBC	20	150	P100092
T25 L.49MMBC	25	49	P100474
T25 L.70MMBC	25	70	P101157

Sold in box of 10 pieces

TORX® MMBC - SPARE BITS (WITHOUT RING)



Designation	Footprint T	Length (mm)	Code
T10 L.49	10	49	P105467
T10 L.70	10	70	P103415
T15 L.49	15	49	P112352
T15 L.70	15	70	P172000
T20 L.49	20	49	P100954
T20 L.75	20	75	P101762
T20 L.150	20	150	P102635

Sold in box of 10 pieces

SPARE MAGNETIC RING FOR MMBC BITS



Designation	Diameter (mm)	Length (mm)	Code
Spare magnetic	12	17	P100266

Sold in box of 10 pieces

IMPACT RANGE

BITS FOR IMPACT WRENCH AND PULSE TOOL

PHILLIPS IMPACT - C6,3 DRIVE



Designation	Footprint PH	Length (mm)	Code
PH2 L.25 - Impact	2	25	P170543
PH3 L.25 - Impact	3	25	P170544

Sold in box of 10 pieces

PHILLIPS IMPACT - E6,3 DRIVE



Designation	Footprint PH	Length (mm)	Code
PH2 L.50 - Impact	2	50	P108409
PH3 L.50 - Impact	3	50	P108411

Sold in box of 5 pieces

POZIDRIV® IMPACT - C6,3 DRIVE



Designation	Footprint PZ	Length (mm)	Code
PZ2 L.25 - Impact	2	25	P170545
PZ3 L.25 - Impact	3	25	P170546

Sold in box of 10 pieces

POZIDRIV® IMPACT - E6,3 DRIVE



Designation	Footprint PZ	Length (mm)	Code
PZ2 L.50 - Impact	2	50	P111929
PZ3 L.50 - Impact	3	50	P111931

Sold in box of 5 pieces

SOCKET HEAD (HEX INT) IMPACT - C6,3 DRIVE



Designation	Footprint H (mm)	Length (mm)	Code
H4 L.25 - Impact	4	25	P170548
H5 L.25 - Impact	5	25	P108431
H6 L.25 - Impact	6	25	P170549

Sold in box of 10 pieces

SOCKET HEAD (HEX INT) IMPACT - E6,3 DRIVE



Designation	Footprint H (mm)	Length (mm)	Code
H4 L.50 - Impact	4	50	P104730
H5 L.50 - Impact	5	50	P103117
H6 L.50 - Impact	6	50	P104825

Sold in box of 5 pieces

TORX® IMPACT - C6,3 DRIVE



Designation	Footprint T	Length (mm)	Code
T20 L.25 - Impact	20	25	P179054
T25 L.25 - Impact	25	25	P111933
T30 L.25 - Impact	30	25	P111935
T40 L.25 - Impact	40	25	P170547

Sold in box of 10 pieces

TORX® IMPACT - E6,3 DRIVE



Designation	Footprint T	Length (mm)	Code
T20 L.50 - Impact	20	50	P108417
T25 L.50 - Impact	25	50	P103424
T30 L.50 - Impact	30	50	P108427
T40 L.50 - Impact	40	50	P108429

Sold in box of 5 pieces

SQUARE IMPACT - C6,3 DRIVE



Designation	Footprint SQ	P1 (mm)	P2 (mm)	Length (mm)	Code
Q2 L.25 - Impact	2	2,85	3,1	25	P170550
Q3 L.25 - Impact	3	3,37	3,7	25	P170551

Sold in box of 10 pieces

SQUARE IMPACT - E6,3 DRIVE



Designation	Footprint SQ	P1 (mm)	P2 (mm)	Length (mm)	Code
Q2 L.50 - Impact	2	2.85	3.1	50	P170552
Q3 L.50 - Impact	3	3.37	3.7	50	P170553

Sold in box of 5 pieces

BIT HOLDER IMPACT - E6,3 DRIVE



Designation	Output	Length (mm)	Code
Impact bit holder with magnetic ring	For C6,3 bit	75	P104829

BIT HOLDER IMPACT - E6,3 DRIVE



Designation	Output	Length (mm)	Code
Magnetic Impact bit holder	For C6,3 bit	75	P105534

SAFETY BITS

1 000 V

- ▶ Safety bits 1 000 V in accordance with DIN IEC 6090:2018.
- ▶ A colour for each type of footprint.

SLOT - E6,3 DRIVE

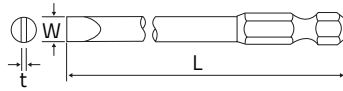

Désignation	Épaisseur de fente t (mm)	Largeur de fente W (mm)	Longueur L (mm)	Code article
SL 3,5 x 0,6	0.6	3.5	125	P124744
SL 4,0 x 0,8	0.8	4.0	125	P124745
SL 5,5 x 1,0	1.0	5.5	125	P124746
SL 6,5 x 1,2	1.2	6.5	125	P124747

POZIDRIV® - E6,3 DRIVE



Designation	Footprint PZ	Length (mm)	Code
PZ1	1	125	P124748
PZ2	2	125	P124749

PHILLIPS - E6,3 DRIVE



Designation	Footprint PH	Length (mm)	Code
PH1	1	125	P124750
PH2	2	125	P124751

TORX® - E6,3 DRIVE



Designation	Footprint T	Length (mm)	Code
T10	10	125	P124752
T15	15	125	P124753
T20	20	125	P124754
T25	25	125	P124755

+ / - Z - E6,3 DRIVE



Designation	Footprint Z	Length (mm)	Code
Z1	1	125	P124756
Z2	2	125	P124757

SQUARE - E6,3 DRIVE



Designation	Footprint SQ	Length (mm)	Code
SQ1	1	125	P124758
SQ2	2	115	P124759

IEC SAFETY BITS



BIT HOLDERS AND ACCESSORIES

BIT HOLDER WITH MAGNETIC RING



Designation	Drive	Output	Diameter (mm)	Length (mm)	Code
MBC	E6,3 - Hexagonal 1/4"	For bit C6,3	17	71	P100069

BIT HOLDERS WITH MAGNETIC RING - WITHOUT C-RING



Designation	Drive	Output	Diameter (mm)	Length (mm)	Code
MBH150	E6,3 - Hexagonal 1/4"	For bit C6,3	17	150	P104784
MBH450	E6,3 - Hexagonal 1/4"	For bit C6,3	11.1	450	P100841

MAGNETIC BIT HOLDERS - WITH QUICK RELEASE CHUCK



Designation	Drive	Output	Diameter (mm)	Length (mm)	Code
RAPID50	E6,3 - Hexagonal 1/4"	For bit C6,3 ou E6,3	15	50	P100088
RAPID75	E6,3 - Hexagonal 1/4"	For bit C6,3 ou E6,3	15	75	P102245
RAPID100	E6,3 - Hexagonal 1/4"	For bit C6,3 ou E6,3	15	100	P101779

MAGNETIC BIT HOLDERS



Designation	Drive	Output	Diameter (mm)	Depth (mm)	Length (mm)	Code
DBHM-01	E6,3 - Hexagonal 1/4"	For bit C6,3	11.1	9,5	60	P100100
3314M/75	E6,3 - Hexagonal 1/4"	For bit C6,3	11.1	10	75	P100564
BH44M	E6,3 - Hexagonal 1/4"	For bit C6,3	11.1	10	102	P100502
BH46M	E6,3 - Hexagonal 1/4"	For bit C6,3	11.1	10	152	P100305

STANDARD BIT HOLDERS



Designation	Drive	Output	Diameter (mm)	Depth (mm)	Length (mm)	Code
DBH-01	E6,3 - Hexagonal 1/4"	For bit C6,3	11.1	9.5	60	P101107
BH44	E6,3 - Hexagonal 1/4"	For bit C6,3	11.1	10	102	P103420
BH46	E6,3 - Hexagonal 1/4"	For bit C6,3	11.1	10	152	P101216

HEXAGONAL 1/4" - HALF-MOON 4 MM ADAPTER



Designation	Drive	Output	Length (mm)	Code
HD71	E6,3 - Hexagonal 1/4"	For half-moon bit 4 mm	41.5	P100442

HEXAGONAL 1/4" - MAGNETIC HALF-MOON 4 MM ADAPTER



Designation	Drive	Output	Length (mm)	Code
BH423M	Half-moon 4 mm	For bit C6,3	75	P100363

BIT HOLDERS - WITH QUICK RELEASE CHUCK FOR HALF-MOON 4 MM OR HIOS 4 MM



Designation	Drive	Output	Length (mm)	Code
E-DHL	E6,3 - Hexagonal 1/4"	For half-moon 4 mm or Hios 4 mm bit	50	P104744
DL-DLH	Half-moon 4 mm	For half-moon 4 mm or Hios 4 mm bit	50	P112168
H-DLH	Hios 4 mm	For half-moon 4 mm or Hios 4 mm bit	50	P170559

INDIVIDUAL MAGNET RINGS FOR E6,3 BITS



Designation	Diameter (mm)	Packaging	Code
Mag'O Net 4,7 mm	4.7 mm	Sold in bags of 10 pieces	P100024
Mag'O Net 7 mm	7.0 mm	Sold in bags of 10 pieces	P100004

MAGNETIZER-DEMAGNETIZER RING KIT



Applicable sizes

- ▶ Hexagonal 6.35 mm
- ▶ Round, shank diameter 4 ~ 6.4 mm

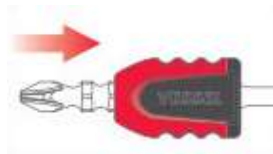

Magnetises the bit

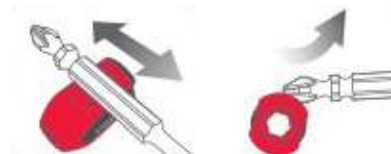

Demagnetises the bit

Designation	Code	
NMC-2P*	P108994	
NMS-2PG	P110608	
NMS-2PY	P172008	
NMS-2PB	P110610	
NMS-2PR	P110616	

Sold in box of 2 pieces - *Available while stocks last

HAND DRIVERS

SCREW GRABS

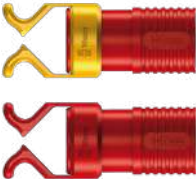

Designation	Composition	Length (mm)	Code	
1441SB	Screw grab for bits diameter 4.5 to 6.0 mm	41	P106725	
1440-1442	Set of two screw grabs: - One screw grab for bits diameter 4.5 to 6.0 mm - One screw grab for bits diameter 6.0 to 8.5 mm	41	P103771	

RATCHET SCREWDRIVER WITH MAGNETIC BIT HOLDER

- ▶ Fits for quick change bits C6,3 and E6,3
- ▶ Ratchet with small tothing allowing small rework angle
- ▶ Inversion ring (right, left, fixed)
- ▶ Max torque 50 Nm
- ▶ Fast magnetic chuck
- ▶ Handle length : 142 mm

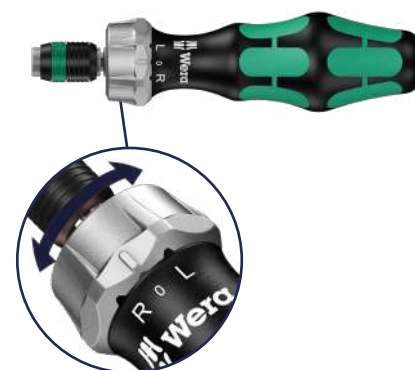

Designation	Code
Ratchet screwdriver with magnetic bit holder	P108614

ADAPTERS

MALE HEX DRIVE E6,3 1/4" -> MALE SQUARE



Designation	Drive	Output	Retainer model	Length (mm)	Code
X5001	E6,3 - Hexagonal 1/4"	Square 1/4"	Pin	35	P102120
B0531	E6,3 - Hexagonal 1/4"	Square 1/4"	Pin	50	P102128
X5002	E6,3 - Hexagonal 1/4"	Square 1/4"	Pin	51	P100750
X5003	E6,3 - Hexagonal 1/4"	Square 1/4"	Pin	76	P102259
X5004	E6,3 - Hexagonal 1/4"	Square 1/4"	Pin	102	P102249
X5005	E6,3 - Hexagonal 1/4"	Square 1/4"	Pin	152	P101679
X5011	E6,3 - Hexagonal 1/4"	Square 3/8"	Pin	43	P100772
X5012	E6,3 - Hexagonal 1/4"	Square 3/8"	Pin	51	P101163
X5013	E6,3 - Hexagonal 1/4"	Square 3/8"	Pin	76	P103115
X5014	E6,3 - Hexagonal 1/4"	Square 3/8"	Pin	102	P105528
X5015	E6,3 - Hexagonal 1/4"	Square 3/8"	Pin	152	P103087
X5021	E6,3 - Hexagonal 1/4"	Square 1/2"	Pin	51	P101263

FEMALE SQUARE / FEMALE HEX 1/4" WITH QUICK RELEASED CHUCK



Drive	Output	Length (mm)	Code
Square 1/4"	For bit E6,3 - Hexagonal 1/4"	38	P100753
Square 3/8"	For bit E6,3 - Hexagonal 1/4"	45	P100364
Square 1/2"	For bit E6,3 - Hexagonal 1/4"	54	P103426

FEMALE SQUARE / C6,3 BIT HOLDER - FAST CHUCK



Designation	Drive	Output	Length (mm)	Code
784A	Square 1/4"	For C6,3 bit holder - Hexagonal 1/4"	30	P102626
784B	Square 3/8"	For C6,3 bit holder - Hexagonal 1/4"	43	P102850
784C	Square 1/2"	For C6,3 bit holder - Hexagonal 1/4"	50	P106737

FEMALE SQUARE / FEMALE HEX 1/4"



Designation	Drive	Output	Length L (mm)	Code
DM825	Square 1/4"	For bit C6,3 - Hexagonal 1/4"	25,4	P102267
2801	Square 3/8"	For bit C6,3 - Hexagonal 1/4"	38	P101680

FEMALE SQUARE / FEMALE HEX 1/4" / MAGNETIC



Designation	Drive	Output	Length L (mm)	Code
M825	Square 1/4"	For bit C6,3 - Hexagonal 1/4"	57.2	P104819

TIGHTENING TORQUE ABACUS

USE OF TORQUE ABACUS

The torque abacus presented in this section are taken from standard NF E25-030-1 2014 edition. These abacus can be used as follows:

► Dimensional and material criteria:

- Dimensioning of the outside diameter of the bearing surface under the head for a hexagon-head screw with a coarse pitch, in accordance with standards NF EN ISO 4014 or NF EN ISO 4017.
- Dimensioning with an internal diameter of the bearing surface corresponding to the through hole for the medium series in accordance with standard NF EN 20273.
- Quality class 6-8 to 12-9 joining elements.

► Mounting conditions (coefficient of friction μ) - see NF EN ISO 16047:

- **Low coefficient of friction: μ between 0.06 and 0.09**
Coatings and lubricants such as phosphating with specific organic lubricants, greases or molybdenum disulphide oil (MoS₂) can be applied.
- **Average coefficient of friction: μ between 0.08 and 0.14**
Coating such as zinc or passivated zinc alloy and a specific rough finish or engine oil can be applied.
- **Normal coefficient of friction: μ between 0.12 and 0.18**
Coating such as electrolytic coating or zinc flake coating (see NF EN ISO 4042 or ISO 10683) and a specific finish can be applied.
- **Uncontrolled coefficient of friction: μ between 0.20 and 0.40 or more**
Unlubricated, the finish can be, for example, uncoated, hot-dip galvanised or stainless steel.

► Calculated tightening torque and its application:

- Torque calculated for maximum tightening corresponding to an equivalent stress of 90% of the elastic limit of the screw.
- Applied torque with a class C10 tool (good precision tool with an accuracy of +/- 10% on applied torque).



These tables are for guidance only and should only be used if calculations have not been carried out and optimisation is not being sought.

Caution should be exercised if any of the above criteria are not met (in particular, attention should be paid to the assembly tool, the shape of the screw head and the coefficient of friction).

DOGA cannot be held responsible for the use of these abacus.

			Quality class					
			A2-70 A4-70	6-8	A2-80 A4-80	8-8	10-9	12-9
Diameter	Standard pitch thread (mm)	Coefficient of friction	Torque abacus (Nm)					
M1,6	0.35	$\Delta\mu = 0.06 - 0.09$	0.07	0.07	0.09	0.10	0.14	0.16
		$\Delta\mu = 0.08 - 0.14$	0.08	0.08	0.11	0.11	0.16	0.19
		$\Delta\mu = 0.12 - 0.18$	0.10	0.11	0.13	0.14	0.21	0.24
		$\Delta\mu = 0.20 - 0.40$	0.13	0.14	0.17	0.18	0.27	0.31
M2	0.4	$\Delta\mu = 0.06 - 0.09$	0.14	0.15	0.19	0.20	0.29	0.34
		$\Delta\mu = 0.08 - 0.14$	0.17	0.18	0.22	0.23	0.35	0.40
		$\Delta\mu = 0.12 - 0.18$	0.21	0.22	0.28	0.30	0.44	0.51
		$\Delta\mu = 0.20 - 0.40$	0.27	0.29	0.36	0.39	0.57	0.67
M2,5	0.45	$\Delta\mu = 0.06 - 0.09$	0.28	0.30	0.38	0.40	0.59	0.69
		$\Delta\mu = 0.08 - 0.14$	0.34	0.36	0.45	0.48	0.71	0.83
		$\Delta\mu = 0.12 - 0.18$	0.43	0.46	0.58	0.62	0.91	1.06
		$\Delta\mu = 0.20 - 0.40$	0.57	0.61	0.76	0.81	1.19	1.39
M3	0.5	$\Delta\mu = 0.06 - 0.09$	0.49	0.52	0.65	0.70	1.02	1.20
		$\Delta\mu = 0.08 - 0.14$	0.59	0.63	0.78	0.84	1.23	1.44
		$\Delta\mu = 0.12 - 0.18$	0.76	0.81	1.0	1.1	1.6	1.8
		$\Delta\mu = 0.20 - 0.40$	1.0	1.1	1.3	1.4	2.1	2.4
M4	0.7	$\Delta\mu = 0.06 - 0.09$	1.1	1.2	1.5	1.6	2.4	2.8
		$\Delta\mu = 0.08 - 0.14$	1.4	1.4	1.8	1.9	2.8	3.3
		$\Delta\mu = 0.12 - 0.18$	1.7	1.9	2.3	2.5	3.6	4.3
		$\Delta\mu = 0.20 - 0.40$	2.3	2.4	3.0	3.3	4.8	5.6
M5	0.8	$\Delta\mu = 0.06 - 0.09$	2.2	2.4	3.0	3.2	4.7	5.4
		$\Delta\mu = 0.08 - 0.14$	2.7	2.9	3.6	3.8	5.6	6.5
		$\Delta\mu = 0.12 - 0.18$	3.4	3.7	4.6	4.9	7.2	8.4
		$\Delta\mu = 0.20 - 0.40$	4.6	4.9	6.1	6.5	9.5	11
M6	1	$\Delta\mu = 0.06 - 0.09$	3.9	4.1	5.2	5.5	8.1	9.5
		$\Delta\mu = 0.08 - 0.14$	4.6	5.0	6.2	6.6	9.7	11
		$\Delta\mu = 0.12 - 0.18$	6.0	6.4	8.0	8.5	12	15
		$\Delta\mu = 0.20 - 0.40$	7.9	8.4	10	11	16	19
M8	1.25	$\Delta\mu = 0.06 - 0.09$	9.3	9.9	12	13	19	23
		$\Delta\mu = 0.08 - 0.14$	11	12	15	16	23	27
		$\Delta\mu = 0.12 - 0.18$	15	15	19	21	30	35
		$\Delta\mu = 0.20 - 0.40$	19	20	26	27	40	47
M10	1.5	$\Delta\mu = 0.06 - 0.09$	18	20	24	26	38	45
		$\Delta\mu = 0.08 - 0.14$	22	24	29	31	46	54
		$\Delta\mu = 0.12 - 0.18$	29	31	38	41	60	70
		$\Delta\mu = 0.20 - 0.40$	38	41	51	54	80	93
M12	1.75	$\Delta\mu = 0.06 - 0.09$	32	34	42	45	66	77
		$\Delta\mu = 0.08 - 0.14$	38	41	51	54	80	93
		$\Delta\mu = 0.12 - 0.18$	49	53	66	70	103	121
		$\Delta\mu = 0.20 - 0.40$	66	70	88	94	138	161
M16	2	$\Delta\mu = 0.06 - 0.09$	76	82	102	109	160	187
		$\Delta\mu = 0.08 - 0.14$	93	100	124	133	195	228
		$\Delta\mu = 0.12 - 0.18$	123	131	163	174	256	300
		$\Delta\mu = 0.20 - 0.40$	165	176	220	234	344	403



RELATED PRODUCTS



Assembly tools

By combining the wide range of DOGA industrial screwdrivers and the choices we make together, we will meet your production and quality requirements

- Torque and angle current control tools
- Torque and angle transducerized control tools - STANLEY®
- Brushless electric tools



BS-5C Color ID bit tray

Improve your productivity and eliminate errors due to incorrect selection of the program associated with the bit or socket

DOGA**TEC**

Mit Sicherheit montiert

Vertrieb Deutschland und Österreich
DOGAtec GmbH | D-73430 Aalen |
Tel 0049 7361 8049950 | www.dogatec.de |

© DOGA | DOC.60292.10/24

We constantly strive to improve our products. As a result, the dimensions and indications in this document may not always correspond to the latest production. By explicit agreement, our sales are subject to a reservation of title (the provisions of the French 05/12/1980 Act are therefore fully applicable).